



Smart Charging



Alfen Charging Equipment Implementation Guide



1.	Intro	3			
1.1	Introduction	3	5.1.3	Active Load Balancing with an Energy Management System	20
1.1.1	Disclaimer	3	5.1.4	Scenarios ALB	21
1.1.2	Copyright	3	5.1.4.1	Scenario ALB with smart energy meter	21
1.1.3	Abbreviations	3	5.1.4.2	Scenario ALB with smart energy meter and EMS	21
2.	Functionalities Alfen charging stations	4	5.1.4.3	Scenario ALB with integrated PV in combination with smart energy meter	22
2.1	Smart charging	4	5.1.4.4	Scenario ALB in combination with smart energy meter, EMS and integrated PV	24
2.1.1	Smart Charging settings	4	5.2	User interface	24
2.1.2	Static charging	5	5.3	Installation	25
2.2	Purchase and unlock Smart Charging features	5	5.3.1	Requirements	25
2.2.1	Unlock features via the ACE Service Installer	5	5.3.1.1	Requirements ALB via (D)SMR P1 port	25
2.2.2	Unlock features via a back office	6	5.3.1.2	Requirements ALB via an external Modbus TCP/IP meter	25
2.3	Over current protection	6	5.3.1.3	Requirements ALB via Energy Management System	26
2.4	Alternating	6	5.3.2	Ethernet connector	26
2.5	Probing phase	6	5.3.3	Configuration of Active Load Balancing	27
2.5.1	Configuration of the probing current via the ACE Service Installer	7	5.3.3.1	Configuration of ALB via the ACE Service Installer	27
2.5.2	Configuration of the probing current via a back office	7	5.3.3.2	Configuration of a Modbus TCP/IP meter via the ACE Service Installer	28
2.6	Internal phase rotation	7	5.3.3.3	Configuration of an EMS via the ACE Service Installer	28
2.7	Mode 3 protocol	7	5.3.3.4	Configuration of ALB via a back office system	29
2.7.1	Charging station behavior and user interfacing	8	5.3.3.5	Configuration of a DSMR P1 meter via a back office	29
3.	Additional installation recommendations	10	5.3.3.6	Configuration of a Modbus TCP/IP meter via a back office	29
3.1	Installation recommendations	10	5.3.3.7	Configuration of an EMS via a back office	30
3.1.1	Phase sequence	10	5.3.4	Verification and testing ALB	30
3.1.1.1	Examples phase sequence	11	5.3.4.1	Verification of ALB with a smart energy meter	31
3.1.2	Dual feeder cable charging station	12	5.3.4.2	Verification of ALB with an EMS	31
3.1.2.1	Configuration of a dual feeder cable charging station	13	6.	Smart Charging Network	32
4.	Standard Load Balancing	15	6.1	Smart Charging Network	32
4.1	Standard Load Balancing	15	6.1.1	Scenarios SCN	32
4.1.1	Scenarios SLB	15	6.1.1.1	Scenarios 1 phase SCN	32
4.1.2	Examples SLB	16	6.1.1.2	Scenarios 3 phase SCN	33
4.2	User interface	16	6.1.1.3	Active Load Balancing and SCN	35
4.3	Installation	17	6.1.1.4	Double socket charging stations in SCN	35
4.3.1	Requirements SLB	17	6.1.2	Dual feeder cable charging stations in an SCN	35
4.3.2	Installation	17	6.1.3	Phase sequence in an SCN	36
4.3.3	Configuration of SLB via the ACE Service Installer	17	6.1.3.1	Scenarios phase sequence in an SCN	37
4.3.4	Configuration of SLB via a back office	17	6.2	User interface	38
4.3.5	Verification and testing SLB	18	6.3	Installation	38
4.3.5.1	Verify SLB via the ACE Service Installer	18	6.3.1	Requirements SCN	38
4.3.5.2	Verify SLB using the display of the charging station	18	6.3.2	Installing a Smart Charging Network	39
5.	Active Load Balancing	19	6.3.3	Configuration of a Smart Charging Network	40
5.1	Active Load Balancing	19			
5.1.1	Active Load Balancing with a smart energy meter (P1 port)	19			
5.1.2	Active Load Balancing with a smart energy	19			

TABLE OF CONTENTS

6.3.3.1	Create a new SCN via the ACE Service Installer	40
6.3.3.2	Configure SCN settings via ACE Service Installer	41
6.3.3.3	Configure charging station for SCN via ACE Service Installer	42
6.3.3.4	Configure SCN and charging station via a back office	43
6.3.4	Verification	44
6.3.4.1	Verify SCN via the ACE Service Installer	44
6.3.4.2	Verify SCN via a back office	44
7.	OCPP 1.6 Smart Charging profiles	45
7.1	Smart Charging profiles	45
7.2	OCPP Smart Charging parameters	45
8.	Suspend Charging Mode	46
8.1	Suspend Charging Mode	46
8.2	Scenarios Suspend Charging Mode	46
9.	Compatibility Smart Charging features	47
9.1	Compatibility features	47
9.2	Combination	47
9.2.1	Additional requirements SCN in combination with smart meter P1 port	48
9.2.2	Additional requirements SCN in combination with smart meter TCP/IP	48
9.2.3	Additional requirements SCN in combination with EMS	48
9.2.4	Additional requirements SCN in combination with a back office	49
9.2.5	Scenario ALB and OCPP Smart Charging	49
9.2.6	SCN in combination with Active Load Balancing	49
10.	General error handling	50
10.1	Troubleshooting	50
10.2	Unable to log in to ACE Service Installer	50
10.3	No internet connection on laptop while connected to the charging station	50
10.4	Unable to reach update server	50
10.5	Charging station not visible in the ACE Service Installer	50
10.6	SCN overview and settings not visible in ACE Service Installer	51
10.7	Unable to configure smart charging functionality	51
10.8	Charging slower than expected	51
10.9	Charging station loses connection to SCN	51
10.10	Charging station or SCN loses communication with (D)SMR meter P1 port	51
10.11	Charging station or SCN loses communication with Modbus TCP/IP meter or EMS	52

1.1 Introduction

This System Description describes the Smart Charging features supported on Alfen charging equipment.

For more information about the Alfen charging stations, please refer to the product specific Original User Manual and Quick Installation Guide. The safety warnings in these documents are also applicable to this System Description.

1.1.1 Disclaimer

This document has been subjected to rigorous technical review before being published. It is revised at regular intervals, and any modifications and amendments are included in the subsequent issues. The content of this document has been compiled for information purposes only.

Although Alfen has made its best efforts to keep the document as precise and up-to-date as possible, Alfen shall not assume any liability for defects and damage which results from the use of the information contained herein.

1.1.2 Copyright

Copyright © Alfen N.V. 2019. All rights reserved. The disclosure, duplication, distribution and editing of this document, or utilization and communication of the content are not permitted, unless authorized in writing. All rights, including rights created by patent grant or registration of a utility model or a design, are reserved.

1.1.3 Abbreviations

The following abbreviations are used in this document:

Abbreviation	Meaning
A	Ampere [A]
ALB	Active Load Balancing
APN	Access Point Name
DHCP	Dynamic Host Configuration Protocol
DSMR	Dutch Smart Meter Requirements
EMS	Energy Management System
eSMR	European Smart Meter Requirements
EV	Electric Vehicle
FTP	File Transfer Protocol
GPRS	General Packet Radio Service
ICU	Integrated Charging Units

Abbreviation	Meaning
ID	Identity
IP	Internet Protocol
kW	Kilowatt [kW]
L (L1 L2 L3)	Phase (1, 2, 3)
LED	Light-emitting Diode
Mbps	Megabits per second
mDNS	Multicast Domain Name System
N	Neutral
OCPP	Open Charge Point Protocol
PE	Protective Earth
PV	Photovoltaic
RJ (11/45)	Registered Jack
RS(485)	Recommended Standard
SCN	Smart Charging Network
SIM	Subscriber Identity Module
SLB	Standard Load Balancing
TCP/IP	Transmission Control Protocol/Internet Protocol
UDP	User Datagram Protocol
UTP	Unshielded Twisted Pair
V	Voltage [V]

2. FUNCTIONALITIES ALFEN CHARGING STATIONS

2.1 Smart charging

Alfen offers a range of functionalities which support Smart Charging:

- Standard load balancing (SLB)
- Active load balancing (ALB)
 - Meter, TCP/IP or DSMR/eSMR
 - Energy Management System (EMS)
- Smart Charging Network (SCN)
- OCPP smart charging profiles
- Suspend Charging Mode (SCM)

The aim of smart charging is to make the best use of the available power, with the focus on charging electric vehicles with optimal power. The charging station can therefore use the data from external information sources within the boundaries of the existing protocols.

Alfen's Smart Charging features, as described in this document, are developed to protect against overcurrent situations and to ensure an optimum distribution of the available power.

This chapter describes the standard functionalities for all Alfen charging stations. These functionalities support the additional smart charging features as described in the following chapters.

2.1.1 Smart Charging settings

Below the parameters to configure smart charging settings via the ACE Service Installer or back office are shown.

The configuration procedures of the smart charging features are described elsewhere in this document.

ACE Service Installer	Back office OCPP
License Key	FeatureLicenseKey
License Key features	UnlockedFeatures
Station maximum current	Station-MaxCurrent
Connector 1 max current	Connector1-MaxCurrent
Connector 1.2 Max current	Connector1.2-MaxCurrent
Connector 2 max current	Connector2-MaxCurrent
Connector 2.2 Max current	Connector2.2-MaxCurrent
OD_sysMinimumChameleonCurrent	Chameleon-MinCurrent
Phase rotation	Phase-Connected
Standard Load Balancing	Static-LoadBalancing

ACE Service Installer	Back office OCPP
Active Load Balancing	Active-LoadBalancing
Protocol Selection	ALB-ProtocolSelection
Received Measurements	DirectExternalSuspendSignal
	MBTCPSmart-Connection-Type
IP address	MBTCPSmart-IPAddress
Refer to Protocol Selection and Data source setting	MBTCPSmart-IsEnabled
Slave address	MBTCPSmart-SlaveUnitID
TCP/IP Meter Mode	MBTCP-Smart-SlaveMeter-Model
Data Source*	MbsSlaveTCPIP
Safe current (A)	Safe-MaxCurrent
Alternatingperiod (s)	SCN-AlternatingPeriod
Refer to Create a new SCN via the ACE Service Installer	SCN-IsEnabled
Smart Charging Network	SCN-NetworkName
PhaseMapping Socket 1	SCN-PhaseMapping-1
PhaseMapping Socket 2	SCN-PhaseMapping-2
Socket Safecurrent	SCN-SocketSafeCurrent
Total safecurrent (A)	SCN-TotalSafeCurrent
Number of sockets	SCN-SocketCount
Socket ID	SCN-SocketID
Total current	SCN-TotalStaticCurrent
OCPP15 SC type	SmartChargingMode
Maximum smart meter current (A)	SmartMeter-MaxCurrent
Received measurements	SmartMeterIncludesCharger

2. FUNCTIONALITIES ALFEN CHARGING STATIONS

ACE Service Installer	Back office OCPP
Validity time (s)	MbsSlaveTCPValidity-Time
TCP/IP EMS Mode	MbsSlaveTCPMode

* If Data Source = EMS than MbsSlaveTCPMode is On.
If Data Source = meter, than MbsSlaveTCPMode is Off.

2.1.2 Static charging

When no smart charging features are activated on an Alfen charging station the charging station will divide the configured available power equally over both sockets (if applicable).

The maximum power depends on the available power in the installation. This should be configured as well as the maximum power per socket.

2.2 Purchase and unlock Smart Charging features

The Smart Charging features developed by Alfen are paid features. The hard- and software of the Alfen charging stations is developed to support all Smart Charging features. Customers can purchase an Alfen charging station with unlocked features or buy Smart Charging features for their installed base. Alfen will provide the customer with a license key. The customer is responsible for unlocking the feature on the product.

The Smart Charging features can be unlocked via the ACE Service Installer or via a back office. After purchasing a Smart Charging feature Alfen will provide the customer with a license key. This license key should be entered in the configuration of the charging station in order to unlock the feature.

NOTICE

Please note that after unlocking a feature, this feature will still need to be configured.

Be aware that some of the Smart Charging features include others:

Feature	Includes
Active Load Balancing	<ul style="list-style-type: none"> Standard Load Balancing Active Load Balancing

Feature	Includes
Smart Charging Network	<ul style="list-style-type: none"> Standard Load Balancing Active Load Balancing Smart Charging Network

2.2.1 Unlock features via the ACE Service Installer

To unlock the feature via the ACE Service Installer do the following:

1. Open the ACE Service Installer
2. Click on the desired charging station
3. Go to the General info tab and select License key

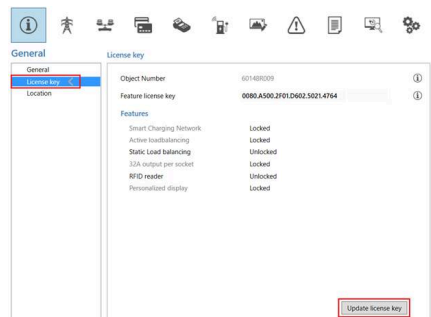

4. Click on Update license key to activate the purchased feature. The charging station will reboot after the update of the license key.

In case the location has a weak internet connection, the following procedure can be executed to unlock the desired feature:

1. Open the ACE Service Installer
2. Go to Device in the menu

2. FUNCTIONALITIES ALFEN CHARGING STATIONS

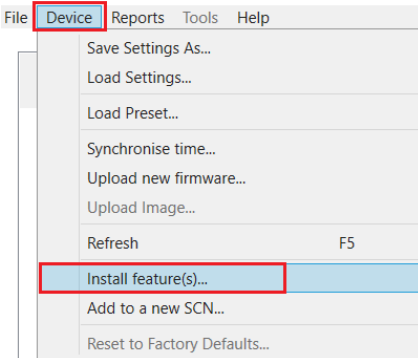

3. Select Install feature(s)
4. Fill in the license key and click Ok. The charging station will reboot after the update of the license key.

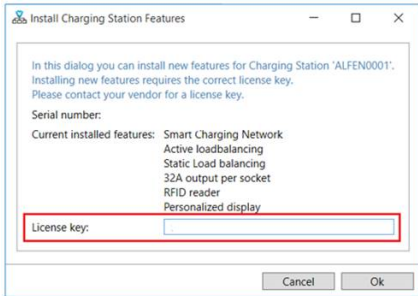

2.2.2 Unlock features via a back office

1. Log in to the back office
2. Go to the Configuration management page of the desired charging station
3. Load current configuration (execute OCPP GetConfiguration)
4. Find the key FeatureLicenseKey and change the value to the license key provided by Alfen
5. Save/send the value to the charging station (execute OCPP ChangeConfiguration)
6. Reboot the charging station

2.3 Over current protection

The mode 3 protocol is used to manage and control the charging speed of a charging station in co-operation with the electric vehicle.

If an electric vehicle uses more power than agreed, the charging station will respond. In this way the charging station contributes to the selectivity of the local installation. The charging station intervenes in over current situations before the Miniature Circuit Breakers (MCBs) and fuses are forced to trip.

The charging station pauses the charging session in case the following situations of over current occur:

- $100\% \leq x < 105\%$ after 1200 seconds
- $105\% \leq x < 112\%$ after 100 seconds
- $112\% \leq x < 120\%$ after 5 seconds
- $120\% \leq x < 150\%$ after 2 seconds

After 5 minutes the charging stations will resume the charging session. In case the over current occurs again the charging station will again pause the charging session for 5 minutes.

After this the charging station will resume the charging session once more. This cycle is repeated until the charging current is decreased (session stopped by user, fully charged EV battery) or the over current situation is resolved in another way.

2.4 Alternating

In case the available power in a charging station or group of charging stations is insufficient to serve all connected EVs, the EVs will be charged alternately.

The available power is divided and communicated to connected EVs, whilst other charging sessions will be resumed for a set period of time. The alternating period can be configured via the ACE Service Installer or via a back office.

When the alternating period has passed, the running charging sessions will be paused and the available power will be communicated to other connected EVs. The allocation of the available power is done according to the order of the socket IDs as configured in the (group of) charging station(s). The occupied socket(s) ID with the lowest ranking (highest socket ID number) will be served first.

2.5 Probing phase

Some electric vehicles require a minimal charging current of 14A. To ensure compatibility with all types of electric vehicles on the Alfen charging stations, the charging sessions start with a probing phase.

When a vehicle is connected the charging station will provide the vehicle with a charging current of 14A (1 or 3 phases depending on the type of EV and power supply). This is called the probing phase. Depending on the maximum available charging current this will imply that

2. FUNCTIONALITIES ALFEN CHARGING STATIONS

other connected vehicles will receive less charging current or will even be charged alternately (when the remaining charging current is $<6A$).

After a minute of probing the software has detected the vehicle as either a vehicle which requires a minimal charging current of 6A or a vehicle which requires a minimal charging current of 14A. The following scenarios are possible:

- The charging station detects a vehicle which requires a minimal charging current of 14A; the charging current will remain at least 14A and the vehicle is being charged. The remaining charging current will be divided over the other sockets in use (in a double socket charging station or SCN).
- The charging station detects a vehicle which requires a minimal charging current of 6A (in accordance with IEC 61851); the charging station will adjust the charging current and divide the available power over the sockets in use (in a double socket charging station or SCN).

The probing current can be set via the ACE Service Installer or a back office. A minimal charging current of 6A is required to ensure charging. Alfen recommends to use a minimal probing current of 14A. If the probing current is set to $<14A$ the probing will still take place, but a vehicle which requires a minimal charging current of 14A will not be detected. If the available charging current is $<14A$ this vehicle will not be able to charge.

2.5.1 Configuration of the probing current via the ACE Service Installer

The probing current can be configured via the Ace Service Installer.

1. Go to the Power settings tab and select Car specific

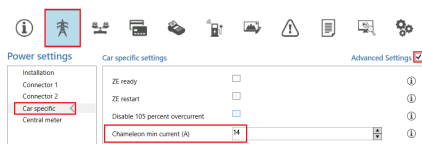

2. Configure the required value ($>6A$) at Chameleon min current (A)

2.5.2 Configuration of the probing current via a back office

1. Log in to the back office and select the charging station
2. Go to the configuration settings (refresh if needed)
3. Go to the setting Chameleon-MinCurrent and set to the required value ($>6A$).

2.6 Internal phase rotation

Alfen 3 phase double socket charging stations are equipped with an internal phase rotation.

This is done to ensure a proportional distribution of the load on the phases. This applies to scenarios where two single phase EVs are connected or one single phase EV and one 2 phase EV. In both cases the EVs use different phases in the charging station. The internal phase rotation is applied on the output of the power meter as followed: socket 1 L3L2L1, socket 2 L1L2L3.

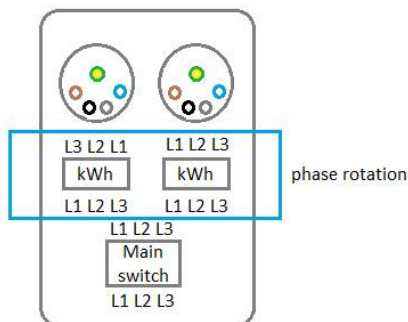

2.7 Mode 3 protocol

Alfen charging stations meet the requirements of the Mode 3 protocol as specified in the IEC 61851.

The IEC 61851 is an international standard for electric vehicle (EV) conductive charging systems. Electric vehicles (EV) cover all road vehicles, including plug-in hybrid road vehicles (PHEV), that derive all or part of their energy from on-board rechargeable energy storage systems.

The IEC 61851 specifies:

- the characteristics and operating conditions of the EV supply equipment;
- the specification of the connection between the EV supply equipment and the EV;
- the requirements for electrical safety for the EV supply equipment

NOTICE

The minimal charging current limit the charging station indicates to the electric vehicle is 6A. This is compliant with the IEC 61851-1 standard (table A7 and A8).

2. FUNCTIONALITIES ALFEN CHARGING STATIONS

2.7.1 Charging station behavior and user interfacing

When using the smart charging features and functionalities of the Alfen charging stations, the charging stations will inform the user via the display or LED. The user interfacing, behavior of the charging station and the Mode 3 states are described in the table below.

Functionality	Behavior charging station	Mode 3 status	User interface
Over current protection	In case an over current is detected, the charging station will pause the charging session. After 5 minutes the charging session will be resumed. In case an over current is detected again, the charging station will repeat the same cycle as described before.	Paused charging session: state C - > F Aborted charging session: state C - > F	Charging stations with a display: An error code will be displayed. The screen shows the following message to the user: 302: One moment please. Your charging session will resume shortly. Charging stations with a LED (no display): The charging station will show a red/blue blinking LED when the charging session is paused or aborted. Back office: A message is send to the back office containing the information of the error: ErrorCode: OverCurrentFailure Info: Over current detected allowed xxA actual xxA Status: Faulted VendorErrorCode: 302
Load balancing/SCN	In case the charging station or SCN divides the available power over the sockets in use it is possible that the max charging current is either limited or increased.	State C2 (charging) or C1 (pausing)	Charging stations with a display will show a reduced power (value does not reach the max power). Charging station with a LED: flashing dark blue LED; charging station requests the first electric vehicle to reduce the charging speed. When charging speed is reduced, the dark blue LED will be on continuously.
Alternating	In case the available power in a charging station or SCN is insufficient to serve all sockets in use, the charging vehicles will be charged alternately. Part of the charging sessions will be paused for the length of a set alternating period, whilst other charging sessions will be resumed.	Paused session: state C2 -> B1 or C1 (depending on the EV) Running session: state C2	Charging stations with a display will show the reduced power (to 0W) in case the charging session is paused. Charging stations with a LED: Charging: dark blue LED Alternating: flashing light blue LED

2. FUNCTIONALITIES ALFEN CHARGING STATIONS

Functionality	Behavior charging station	Mode 3 status	User interface
Probing phase	During the probing phase all sockets in use, except for the socket with the newly connected vehicle, will be paused, but only if the available power is not sufficient to serve all sockets in use.	Paused session: state C2 -> B1 or C1 (depending on the EV) Probing phase newly connected vehicle: state C2	Charging stations with a display: Charging stations with a LED: <ul style="list-style-type: none"> • paused session: the light blue LED will flash • probing phase: the dark blue LED will be on
Suspend Charging mode	A running charging session can be suspended on request of the grid operator. Suspending the charging session is done in a controlled way, according to the Mode 3 protocol. During the shut-off time it is possible to start a new charging session; the session, however, will be paused immediately. The charging station indicates when the session can be resumed.	Running session: State C2 Suspended session: State C2 -> B1 or C1 (depending on the EV)	Charging stations with display will show a message for the user: Charging session halted by energy supplier. Charging station with LED: the blue led will flash to indicate the power supply is halted by the energy supplier. In case the charging station is part of an SCN and the whole SCN is suspended, one station in the SCN will show the message Charging session halted by energy supplier. The other charging stations in the SCN will show the message Chargepoint ready, waiting for power.
OCPP Smart charging profile	With an OCPP Smart charging profile a running charging session can be controlled by an OCPP back office. The profile can be composed of multiple blocks of charging currents for a set amount of time. Be aware that when a Smart charging profile is sent to a charging station with more enabled smart charging features (SCN, Active Load Balancing), the most limiting setpoint communicated with a socket in use prevails.	State C2, depending on the charging profile the charging session can be paused for a set period of time (state C1 or B1).	Charging stations with a display will show the message: Chargepoint ready, waiting for power.

3. ADDITIONAL INSTALLATION RECOMMENDATIONS

3.1 Installation recommendations

Next to the installation recommendations as described in the User Manuals and Quick Installation Guides of the Alfen charging equipment, the following paragraphs describe additional installation recommendations.

These recommendations will support the Smart Charging functionalities to ensure the most optimal use of the available power.

NOTICE

The latest version of the user manuals and quick installation guides of the Alfen products can be downloaded from the website <https://www.alfen.com>.

WARNING

Be aware that the installation and configuration of Alfen products can only be performed by a qualified electrician in accordance with IEC 60364 and the instructions as specified in the product manuals. Failure to do so may lead to injury or cause electrical health and safety issues.

3.1.1 Phase sequence

When installing a charging station it is recommended to investigate the load distribution in relation to the grid connection in order to apply the most optimal phase sequence for the site setup.

Take into consideration the following parameters:

- Grid connection; number of phases, value of the grid connection protection
- Load; inputs (e.g. solar power) and outputs (e.g. other users) on the circuitry where the charging station should be integrated
- Type of charging station; every type of charging station has its own installation recommendations
- Number of charging stations to be installed; in case multiple charging stations are installed as a Smart Charging Network Alfen recommends the applications of a specific phase sequence, which is described in the chapter Smart Charging Network

Alfen recommends to apply the phase sequence as shown in the table below. Note that socket 1 is the left socket and socket 2 the right socket on the charging station.

Setup	Charging station type	Internal phase rotation	Recommendation
Individual charging station, 1 phase (grid) connection, 1 phase charging station	Single socket charging station	n.a.	No phase sequence applicable for single phase connections.
	Double socket charging station (single feeder power supply)	Socket 1: L1 Socket 2: L1	
	Double socket charging station (dual feeder power supply)	Socket 1: L1 Socket 2: L1	

3. ADDITIONAL INSTALLATION RECOMMENDATIONS

Setup	Charging station type	Internal phase rotation	Recommendation
Individual charging station, 3 phase (grid) connection, 3 phase charging station	Single socket charging station	n.a.	No specific recommendation. Depending on the results of the investigation the most appropriate phase sequence should be applied.
	Double socket charging station (single feeder power supply)	Socket 1: L3L2L1 Socket 2: L1L2L3	No specific recommendation. Depending on the results of the investigation the most appropriate phase sequence should be applied.
	Double socket charging station (dual feeder power supply)	Socket 1: L3L2L1 Socket 2: L1L2L3	Unless the location parameters require a different phase sequence it is recommended to apply the same phase sequence for both feeder cables (both L1L2L3). Due to the internal phase rotation single phase EVs will charge on L3 (socket 1) and L1 (socket 2).
Multiple charging stations, 3 phase (grid) connection, 3 phase charging stations	Double socket charging station (single feeder power supply)	Socket 1: L3L2L1 Socket 2: L1L2L3	Alfen recommends to apply the following phase sequence to connect the charging stations: Charging station 1: L1L2L3 Charging station 2: L3L1L2 Charging station 3: L2L3L1 Charging station 4: L1L2L3 and so on...
	Double socket charging station (dual feeder power supply)	Socket 1: L3L2L1 Socket 2: L1L2L3	Alfen recommends to apply the following phase sequence combinations to connect the charging stations (socket 1 and socket 2 respectively): L1L2L3 and L2L3L1 L3L2L1 and L2L3L1 L2L3L1 and L3L2L1

3.1.1.1 Examples phase sequence

When installing a double socket charging station observe the table below. In the examples the available charging current is set to 25A per phase. EVs are connected to both sockets.

3. ADDITIONAL INSTALLATION RECOMMENDATIONS

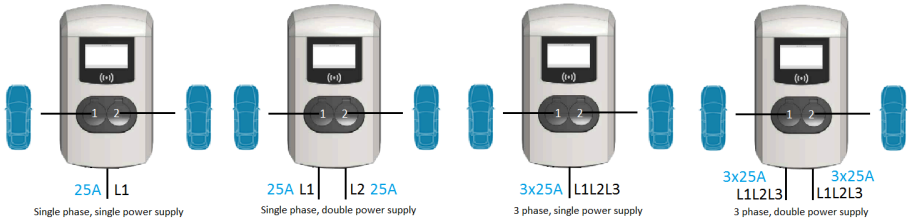

Charging station type	Scenario	Socket 1 connected load	Socket 2 connected load	Charging current socket 1	Charging current socket 2
Single phase, single power supply	A	Single phase EV	Single phase EV	12,5A	12,5A
	B	3 phase EVs will charge on 1 phase, see scenario A			
Single phase, double power supply 1 phase	Note: For this type it is recommended to connect socket 1 to L1 and socket 2 to L2 or L3 in the grid connection cabinet, if possible. The scenarios below are based on this example. If this is not possible, double power supply is only useful when the power supply (e.g. grid connection) can provide 2x25A, else the scenario will be the same as above (single power supply).				
	C	Single phase EV	Single phase EV	25A	25A
	D	2 or 3 phase EVs will charge on 1 phase, see scenario C			
3 phase, single power supply 3 phase	E	Single phase EV	Single phase EV	25A	25A
	F	2 phase EV	Single phase EV	25A	25A
	G	2 phase EV	2 phase EV	12,5A	12,5A
	H	As soon as a 3 phase EV is connected in combination with another load on the remaining socket, the charging current will be divided over the two sockets		12,5A	12,5A
3 phase, double power supply 3 phase	I	Any combination of single EVs. 2 and 3 phase EVs will have no effect on the maximum charging current. All connected vehicles will receive the full charging current of 25A		25A	25A

NOTICE

The charging station should be installed as described in the Alfen User Manual of the specific product.

3.1.2 Dual feeder cable charging station

In 2017 the new international standard for conductive charging systems for electric vehicles was introduced, namely the IEC-61851-1. Charging stations introduced after release of this standard must conform to these new

standards for, among other things, safety and functionality. In the overview below are the most important changes which have direct implication on the design of the Eve Double. By applying this change to the standard in the design of the Eve Double, the product complies with not just today's requirements but also future ones.

3. ADDITIONAL INSTALLATION RECOMMENDATIONS

Regulation

Article 13.1 If the EV supply equipment presents more than one connecting point then such connecting points may have common overload protection means and may have common short-circuit protection means, if those protection means provide the required protection for each of the connecting points (e.g. the common protection device shall have a rating no higher than the lowest rating of the connecting points)

Implications for all charging stations

For charging stations with two outputs, a shared short circuit protection and over-current protection may be applied to the power cable in the installation. However, the value of the protection per power cable must never exceed the output power of one outlet. In other words, a protection of 63A on one power cable while the maximum output power is 32A per socket is not allowed according to the IEC-61851-1 standard.

Implementation in Eve Double Pro-line

The maximum output power of the Eve is 32A per socket, which means that a maximum protection of 32A is permitted for each power cable in accordance with the new standard. This implies that a charging station with an output power of 2x32A cannot be supplied without soft or hardware modifications. For this, Alfen offers two solutions with the Eve Double:

- An output of 32A and one power cable, Load Balancing is always included and activated to meet the standard.
- An output of 32A per socket simultaneously and two power cables, requiring a protection per cable.

NOTICE

The installation of a dual power supply Eve Double Pro-line requires a different approach as the input of two power cables increases the risk for a mechanic when working on the charging station. Observe the installation instructions in the User Manual or Quick Installation Guide of the product.

3.1.2.1 Configuration of a dual feeder cable charging station

charging station with double sockets. However the values of the different settings vary.

The way of configuring a dual feeder cable charging station does not differ from configuring a single feeder cable

In the example below the available charging current per feeder cable is 16A

Charging station type	Parameter/key	Value
Single feeder cable charging station double sockets	Station max current	16A
	Connector 1 max current	16A (<16A when both sockets are in use due standard load balancing)
	Connector 2 max current	16A (<16A when both sockets are in use due standard load balancing)
Dual feeder cable charging station double sockets	Station max current	32A (sum of the value of both feeder cables)
	Connector 1 max current	16A (16A allocated for each socket, no standard load balancing)
	Connector 2 max current	16A (16A allocated for each socket, no standard load balancing)

3. ADDITIONAL INSTALLATION RECOMMENDATIONS



4. STANDARD LOAD BALANCING

4.1 Standard Load Balancing

Standard Load Balancing can be activated on charging stations with multiple sockets. Standard Load Balancing means that the charging station automatically divides the available power over the sockets in use.

The charging station analyses the available capacity and how much power the vehicles use. Subsequently, the smart electronics in the charging station, distribute the power based on the maximum capacity of the connection. With the system, electric vehicles can always be charged, even if the installation has a limited capacity. Thus, no expensive investments have to be done in a more powerful installation.

NOTICE

The Standard Load Balancing feature is optional; a license key is mandatory for activating this feature.

Standard load balancing is used in two different situations:

- In charging stations which necessarily include load balancing based on the norms (e.g. the Eve Double with one power supply cable). On the Eve Double connected to one power supply cable it is possible to charge the

full amount of available power on one socket. When both sockets are in use it is required to divide the available power over the two sockets to avoid over current situations.

- In combination with a grid connection with limited (fixed) capacity.

If the load on one of the phases tends to exceed the maximum, the Standard Load Balancing algorithm will be executed.

Under normal circumstances the load will initially be divided equally over the sockets in use. Due to internal phase rotation in the 3 phase Alfen charging stations the most optimal charging current is realized for single and double phase EVs in specific scenarios.

NOTICE

When a vehicle reaches the status 'fully charged' or gets paused by the user, it will reduce the charging current request. The remaining charging current will be divided over the other socket in use. Threshold for this functionality is a remaining charging current of >3A for a period of time >3 minutes.



Product	Capacity input	Outputs #	Capacity output(s)
Eve Double/Twin	1-phase: 5,7kW (25A)	2	1 socket in use: 5,7kW Both sockets in use: 2,8kW per socket
Eve Double/Twin (single feeder cable)	3-phase: 17,2kW (25A per phase)	2	Single phase EV (individually or simultaneously charging): 5,7kW per socket* Single phase EV in combination with 2 phase EV: 5,7kW (single phase EV) and 11,4kW (2 phase EV)* 3 phase EV: 17,2kW (individually charging) 8,6kW (simultaneously charging with other 3 phase EV) 3 phase EV (8,6kW) in combination with single phase EV (2,8kW) 3 phase EV (8,6kW) in combination with 2 phase EV (5,7kW)
Eve Double (dual feeder cable)	2x3-phase: 2x17,2kW (25A per phase)	2	17,2kW per socket

*Due to internal phase rotation in the Alfen charging stations

4.1.1 Scenarios SLB

The images below show the various situations in case of Standard Load Balancing as well as the corresponding behavior of the charging station.

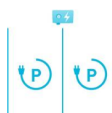

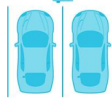
4. STANDARD LOAD BALANCING



Setup	Description
	The charging station is ready to be used. The maximum capacity is available.
	One vehicle is being charged. The maximum amount of power for the station is available for the electric vehicle (EV).
	Two EVs are connected (both require a minimal charging current of 6A). The charging station will divide the available power equally over the two electric cars. It is possible that the EVs are being charged at a lower speed. Depending on the EV and/or available power, it is possible that the EVs will be charged alternately every 15 minutes (configurable setting).

NOTICE
Alternating will start when the available charging current < 6A (minimum charging current) per charging EV.

4.1.2 Examples SLB

Below some examples of the working of Standard Load Balancing are shown.

Setup	Description
	In this case both EVs draw the maximum power, the charging station will divide the available power over the two sockets in use.
	In this case one of the cars demands less than the available power, the charging station will allocate the remaining charging current to the other socket in use.

Setup	Description
	In this case both single phase EVs are charging on a different phase of a three phase charging station, the available power for each EV will be equal to the total available power.
	Two EVs have been connected. One of the EVs requires a minimal charging current of 14A. If the available charging current is < 20A then the charging station will charge the connected EVs alternately every 15 minutes (configurable setting). If the charging current is ≥ 20A then the EV which requires a minimal charging current of 14A will be charged with minimal 14A and the other EV with minimal 6A.

NOTICE
The charging station will start alternating when the available charging current is < 2x6A

4.2 User interface

When Standard Load Balancing is active, this is shown via either the LED or the display on the charging station.

Display status: the display will show the adjusted power.

NOTICE
Be aware that in case the charging current is decreased, the charging capacity (A) will not meet the maximum charging capacity of the socket (B).

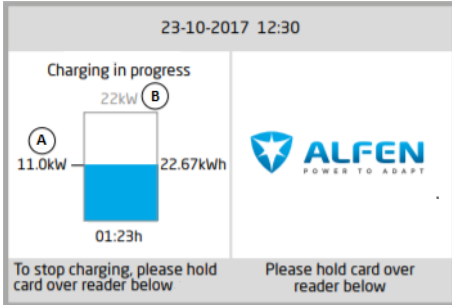

Figure 4.1: Display charging station

LED status; there are two possible situations:

- The status LED flashes dark blue: the charging station requests the first EV to reduce the charging speed so that the power can be divided over the two connected EVs;
- The status LED flashes light blue: the charging process of the second EV will be started as soon as the other EV has adjusted the charging speed. When only one of the EVs can be charged at a time, the LED will alternately flash light blue. The available power is divided over both EVs by charging alternately every 15 minutes. When this indication is shown, charging is currently paused and will resume within 15 minutes (configurable setting).

4.3 Installation

4.3.1 Requirements SLB

To ensure a proper working of the Standard Load Balancing feature, the following requirements should be met:

- Charging station is updated with firmware version **2.0.0** or higher. Alfen recommends to update the charging station with the latest released firmware version.
- Charging station is equipped with an activated Standard Load balancing feature
- Only applicable to charging stations with multiple sockets
- To serve electric vehicles which require a minimal charging current of 14A, a minimum charging current of 14A is required.
- Configuration tool: Alfen ACE Service Installer, **version 2.3.0.96** and higher
- Configuration device (laptop) provided with a Windows operating system
- Valid account for Alfen ACE Service Installer (can be requested via <https://support.alfen.com>)
- Network adapter laptop set to automatic IP
- Open internet connection; FTP server should be accessible to receive updates and feature keys from)
- Disabled blocking firewalls on laptop

4. STANDARD LOAD BALANCING

4.3.2 Installation

For installation of the charging station refer to the User Manual or Quick Installation Guide of the specific product and the additional installation recommendations.

4.3.3 Configuration of SLB via the ACE Service Installer

To configure the Standard Load Balancing feature, do the following:

1. Open the ACE Service Installer
2. Select the required charging station in the menu on the left of the screen
3. Select the Smart Charging tab
4. Select Static balancing in the menu left and select the box next to Standard Load Balancing

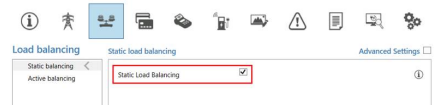

5. Go to the Power settings tab and select Installation. Fill in the Station maximum current.



6. Go to the Power settings tab and select Connector 1. Fill in the correct Socket 1 maximum current. Repeat this step for connector 2.



4.3.4 Configuration of SLB via a back office

To configure the Standard Load Balancing feature:

1. Log in to the back office and select the charging station
2. Go to the configuration settings (refresh if needed)
3. Go to the setting Static-LoadBalancing and set to 'ON'.
4. Go to the setting Station-MaxCurrent and fill in the required value (notation example 20.0).

4. STANDARD LOAD BALANCING

5. Go to the setting Connector1-MaxCurrent and fill in the correct value. Repeat this step for Connector2-MaxCurrent.

4.3.5 Verification and testing SLB

There is no specific need for testing the working of standard load balancing after installation. However, if preferred one may verify the working by connecting two vehicles simultaneously and observe the drawn currents. This can be done by checking the data on the display (if applicable) or monitoring via the ACE Service Installer.

NOTICE

Standard Load Balancing will not occur when the sum of the charging currents < Station maximum current. You may temporarily lower the Station maximum current for the purpose of testing. Alfen recommends to keep this setting >14A as certain EV types do not support lower ratings.

NOTICE

When testing on a 3 phase charging station one of the two EVs has to be a 3 phase charger. Two single phase EVs will not activate the Standard Load Balancing feature as they will not charge on the same phase due to internal phase rotation.

NOTICE

It is not possible to use a test plug and another electrical device (any other than an electric vehicle) to verify the working of smart charging functionalities. Other devices, besides electric vehicles, do not respond conform the Mode 3 protocol and will therefore not adjust their drawn current.

4.3.5.1 Verify SLB via the ACE Service Installer

Make sure to meet the recommendations as described in the Verification and testing SLB paragraph.

1. Connect to the charging station via the Ethernet cable
2. Configure the Station maximum current
3. Connect one EV and start a charging session
4. Go to the Live monitoring tab, select Currents and observe the drawn currents as shown below (note: this is an example):

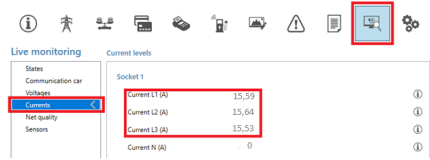

5. Connect a second vehicle and start a transaction.

6. After the probing stage of one minute, the currents for both sockets are shown. The sum of the charging current of the overlapping phases should reach the Station maximum current.

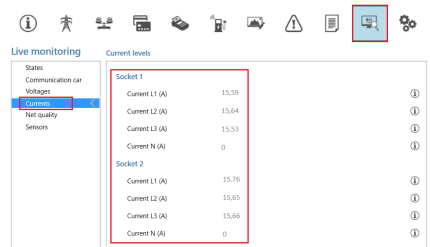

7. Abort one of the charging sessions. The remaining available current will become available for the other vehicle.

4.3.5.2 Verify SLB using the display of the charging station

Make sure to meet the recommendations as described in the Verification and testing SLB paragraph.

1. Connect two EVs and start a charging session on both EVs
2. Lower the charging rate of one of the EVs via the app or board computer
3. Check if the display on the charging station shows that the EV is drawing less power. When drawing >3A less power for a period of 3 minutes, the remaining power will become available for the other EV. This should be visible on the display; the charging power for the other EV increases.

5.1 Active Load Balancing

The Active Load Balancing (ALB) feature offers the same functionality as the Standard Load Balancing (SLB) feature when it comes to dividing the available power in charging stations with multiple sockets.

In addition to this, Active Load Balancing uses input from an external source, like an energy meter or energy management system (EMS), to dynamically manage the available power over the socket(s). The current usage and maximal capacity of the location is taken into account.

An Energy Management System is a system which connects to solar inverters, heat pumps, energy storage and charging stations in order to monitor and control the available and consumed power of these devices. An EMS offers a visual representation of the consumption and generation of power.

With Standard Load Balancing a static power is assigned to the charging station. With Active Load Balancing a dynamic power is used to calculate and assign power to the charging station.

The following devices and protocols can serve as an external data source to the charging station:

1. Smart energy meter
 - (D)SMR 4.0 and higher; equipped with a P1 port, communication via RJ11 cable
 - Modbus TCP/IP; communication via RJ45 communication cable
2. Energy Management System (EMS)
 - Modbus TCP/IP

Alfen is developing hardware to support RS485 energy meters as well.

The charging station and the external data source communicate with each other. Data about the actual consumption and charging needs is regularly exchanged. When limited power is available the charging station will instruct the EV to decrease the charging power. This prevents the charging station from overloading the grid capacity, or prevents additional grid costs from being incurred. In effect, this feature provides for 'peak shaving', distributing the available power during peak moments.

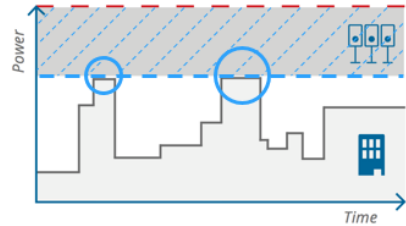

Static Load Balancing

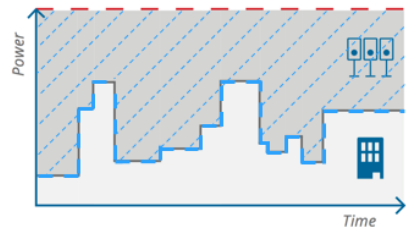

Active Load Balancing

Figure 5.1: SLB and ALB graph

5.1.1 Active Load Balancing with a smart energy meter (P1 port)

The smart energy meter is usually delivered and installed on the grid connection by the grid operator.

When already installed this offers a unique ability to use this energy meter for Active Load Balancing.

If the installation is not equipped with a (D)SMR smart meter it might be beneficial for end customers to compare the installation costs of a Modbus TCP/IP smart meter (installed by a certified installer) to a (D)SMR meter (installed by the grid operator). Both can be used for Active Load Balancing but the (D)SMR option is often cheaper.

The smart energy meter is an energy meter that supports (D)SMR 4.0 or higher via a P1 port. The P1 port is connected to the charging station via an RJ11 communication cable.

5. ACTIVE LOAD BALANCING



Figure 5.2: Active Load Balancing with energy meter (P1 port)

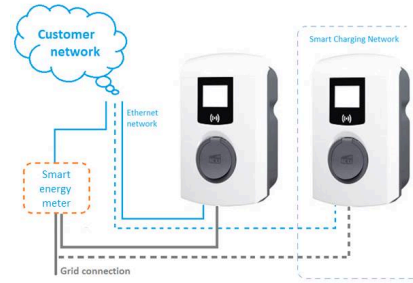

Figure 5.3: Active Load Balancing with energy meter (Modbus TCP/IP)

5.1.2 Active Load Balancing with a smart energy meter (Modbus TCP/IP)

In case it is not possible to have a (D)SMR smart meter installed by the grid operator it is possible to install an additional smart energy meter, which supports Modbus TCP/IP.

The TCP/IP smart meter needs to be installed on the grid connection and is connected to the customer's network or directly to the charging station with an RJ45 Ethernet cable.

The DHCP server of the LAN allocates an IP-address to the charging station. Not all TCP/IP smart meters support DHCP. It is therefore required to manually enter the correct network settings in such smart meters.

When the settings in the smart meter are configured correctly, the charging station should be able to find the IP-address of the smart energy meter. Therefore it is mandatory to connect both the smart energy meter and the charging station to the same network via a router or a switch. For the configuration of the ALB setup with a smart energy meter (Modbus TCP/IP) it is recommended to connect the installers laptop to the customers network via wifi or via the router or switch (wired).

IP-addresses assigned by a DHCP-server are subject to change, therefore it is recommended to configure the DHCP server to reserve fixed IP-addresses for the charging station and the smart energy meter. The configuration procedure for the Socomec E27 can be found in the information document Active Load Balancing via Modbus TCP/IP. For other smart energy meters please refer to the manufacturer manual on how to configure the smart energy meter to a fixed IP -address.

NOTICE

Alfen supports any Modbus TCP/IP meter in the setup. The configuration to connect the Socomec E27 is available as a pre-set. For all other Modbus TCP/IP smart meter brands and types manual configuration may be required.

5.1.3 Active Load Balancing with an Energy Management System

Next to the Active Load Balancing via a smart energy meter, the charging station is also able to communicate with a customer's Energy Management System (EMS). The communication protocol Modbus over TCP/IP is used to transfer data from the EMS to the charging station.

In this case the charging station acts as a 'Slave' and the EMS as a 'Master'. The Energy Management System calculates the available power and sends requests to the charging station(s), e.g. maximum charging current per socket or per group of charging stations. The charging station executes the requests.



Figure 5.4: Modbus Master Slave setup EMS

NOTICE

Alfen configures the charging station to respond to the commands from the EMS. The customer is responsible for the configuration and integration of the charging station into the EMS. Most EMS suppliers can provide support on the configuration and integration. If you need help with this, contact your EMS supplier.

The charging station is connected to the customer's Energy Management System. In this case it is assumed that the customer provides the required smart energy meter in the

setup. The EMS should support the type of energy meter. Both EMS and energy meter need to be purchased and installed and implemented by the customer/customer's contractor.



Figure 5.5: Active Load Balancing with Energy Management System and PV and heatpump

5.1.4 Scenarios ALB

The Active Load Balancing feature can be used in various setups. In combination with a smart meter, EMS, integrated PV, etc. It would go too far to describe all scenarios; in the following paragraphs the most likely scenarios are included.

NOTICE

The response of a charging station to the charging behavior of a vehicle which requires a minimal charging current of 14A in an Active Load Balancing situation is the same as described in the Standard Load Balancing description.

5.1.4.1 Scenario ALB with smart energy meter

Below an example of a use case Active Load Balancing is shown. The measuring device gains data about the power demand of the building. The charging station reads the data from the smart energy meter.

The data is used by the charging stations algorithm to determine the amount of power that can be distributed.

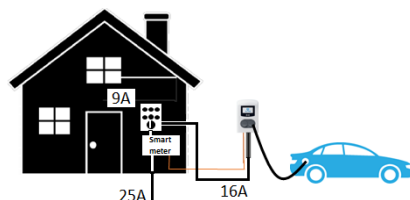

Figure 5.6: Scenario ALB in combination with smart energy meter

This scenario also applies to the scenario ALB in combination with a group of charging stations. In this case one of the charging stations receives the data from the smart energy meter and calculates the available current for the other charging stations.

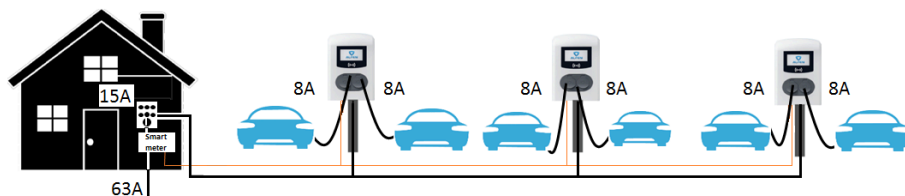

Figure 5.7: Scenario ALB in combination with smart energy meter and multiple charging stations

5.1.4.2 Scenario ALB with smart energy meter and EMS

When an EMS is part of the setup the EMS calculates the available charging power. The EMS sends the available charging power value to the charging station or group of charging stations. The charging station(s) makes sure the charging sessions do not exceed the available power limit.

5. ACTIVE LOAD BALANCING

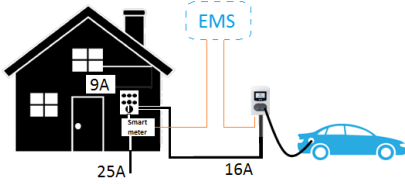

Figure 5.8: Scenario ALB in combination with Smart energy meter and EMS

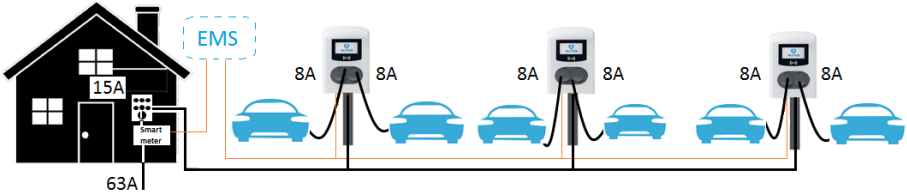

Figure 5.9: Scenario ALB in combination with smart energy meter, EMS and multiple charging stations

5.1.4.3 Scenario ALB with integrated PV in combination with smart energy meter

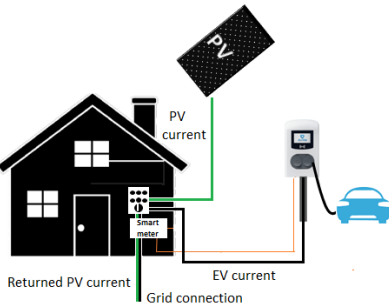

Figure 5.10: Scenario ALB in combination with Smart energy meter and integrated PV

The smart energy meter not only measures the demand of the building but also calculates the returned PV current. Be aware that some smart energy meters can only show

This scenario also applies to the scenario ALB in combination with a group of charging stations. In this case one of the charging stations receives the data from the smart energy meter and calculates the available current for the other charging stations.

positive figures. The firmware of the charging station knows how to interpret these values provided that the settings are correctly configured.

In case the power demand by the measured appliances is equal to the power supplied by the PV, the power flow registered by the smart energy meter equals 0.

In case the demand by the measured appliances is higher than the power supplied by the PV, the power flow registered by the smart energy meter >0 .

When the power supplied by the PV system is higher than the power demanded by the measured appliances, the smart energy meter will register a power flow <0 (negative).

In the table below the different scenarios are shown with their respected current values. Figures with an * are interpreted as negative values by the firmware of the charging station.

Scenario	Smart meter value	PV current	EV current	Household current	Returned PV current
0 PV current, No Charging, 0 House current	0	0	0	0	0
House current	2	0	0	2	0

5. ACTIVE LOAD BALANCING

Scenario	Smart meter value	PV current	EV current	Household current	Returned PV current
Charging	12	0	12	0	0
PV current	12*	12	0	0	-12
PV current and House current are equal	0	12	0	12	0
House current < PV current	12*	12	0	2	-10
PV current + Charging current = Return current	6*	12	6	0	-6
PV current and Charging current are equal	0	12	12	0	0
House current and Charging current < PV current	4*	12	6	2	-4
House current and Charging current equals PV current	0	12	6	6	0
House current and Charging current > PV current	6	12	16	2	0

NOTICE

This table also applies to the scenario ALB in combination with a smart energy meter, PV and an SCN. In this case one of the charging stations in the SCN receives the data from the smart energy meter and calculates the available current for the SCN.

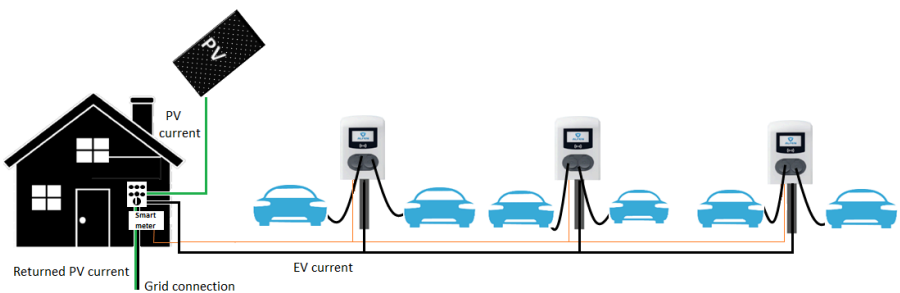

Figure 5.11: Scenario ALB in combination with smart energy meter, SCN and integrated PV

5. ACTIVE LOAD BALANCING

5.1.4.4 Scenario ALB in combination with smart energy meter, EMS and integrated PV

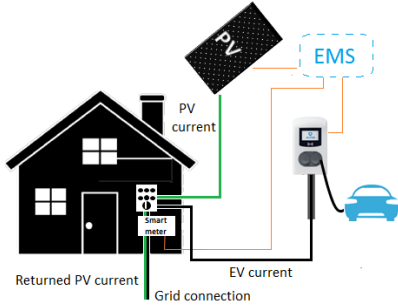

Figure 5.1.2: Scenario ALB in combination with smart energy meter, EMS and integrated PV

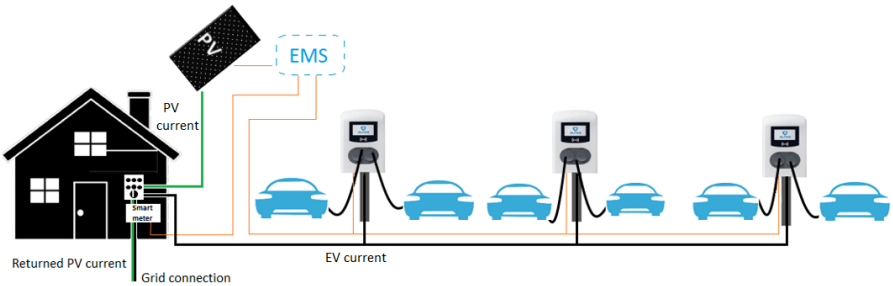

Figure 5.1.3: Scenario ALB in combination with smart energy meter, EMS, SCN and integrated PV

5.2 User interface

When Standard Load Balancing is active, this is shown via either the LED or the display on the charging station.

Display status: the display will show the adjusted power.

NOTICE

Be aware that in case the charging current is decreased, the charging capacity (A) will not meet the maximum charging capacity of the socket (B).

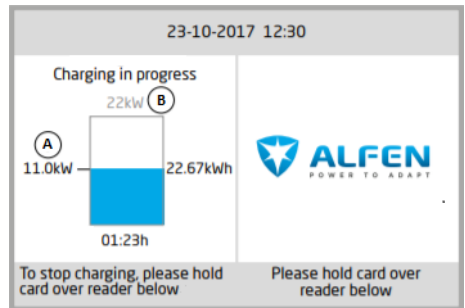

Figure 5.1.4: Display charging station

LED status; there are two possible situations:

- The status LED flashes dark blue: the charging station requests the first EV to reduce the charging speed so that the power can be divided over the two connected EVs;
- The status LED flashes light blue: the charging process of the second EV will be started as soon as the other EV

has adjusted the charging speed. When only one of the EVs can be charged at a time, the LED will alternately flash light blue. The available power is divided over both EVs by charging alternately every 15 minutes. When this indication is shown, charging is currently paused and will resume within 15 minutes (configurable setting).

5.3 Installation

5.3.1 Requirements

5.3.1.1 Requirements ALB via (D)SMR P1 port

To ensure a proper working of the Active Load Balancing feature using the P1 port of a (D)SMR meter (4.0 or higher), the following requirements should be met:

- The Alfen charging station is updated with firmware **version 2.0.0** (or higher)
- The Alfen charging station is equipped with an activated Active Load Balancing feature
- Communication cable with RJ11 (using the middle four contacts) or RJ12 plugs, both straight connected
- Maximum distance between (D)SMR meter and charging station of 20 meters
- Smart meter:
 - a. Supporting (D)SMR 4.0 (and higher) or eSMR 4.0 (and higher) over a P1 port
 - b. Maximum of one Smart energy meter connected to a charging station
- Configuration tool: Alfen ACE Service Installer, **version 2.3.0.96** and higher
- Configuration device (laptop) provided with a Windows operating system
- To serve electric vehicles which require a minimal charging current of 14A, a minimum charging current of 14A is required.
- Valid account for Alfen ACE Service Installer (can be requested via <https://support.alfen.com>)
- Network adapter laptop set to automatic IP
- Open internet connection; Alfen servers should be accessible to receive updates and feature keys from
- Disabled blocking firewalls on laptop
- If the P1 port of the smart meter is already being used by another device, a splitter can be used.

NOTICE

Not all splitters are compatible. Using splitters with two cables may prevent your charging station from being able to communicate with the smart energy meter. Alfen can provide a compatible splitter, article number 803855450-ICU.

NOTICE

Alfen is not liable in any way if a P1 signal amplifier or P1 signal converter is used to transfer the P1 signal over more than 20 meters. Alfen cannot guarantee a proper working of the P1 signal.

5.3.1.2 Requirements ALB via an external Modbus TCP/IP meter

To ensure a proper working of the Active Load Balancing feature via Modbus over TCP/IP, the following requirements should be met:

- The Alfen charging station is updated with firmware **version 3.4.0** (or higher)
- The Alfen charging station is equipped with an activated Active Load Balancing feature
- Communication cable: CAT5e or CAT6 UTP/Ethernet RJ45 cable, cable tracé max. 100m
- Smart meter:
 - a. Supporting Modbus TCP/IP; the charging station will assume the role of the Modbus Master in this configuration. The smart meter is the Slave.



- b. Maximum of one energy meter connected to a charging station
- Network:
 - a. The charging station is located in the same local network as the energy meter
 - b. Network with a minimum speed of 10Mbps
 - c. No power over Ethernet
 - d. Fixed IP address for energy meter, assigned by the network operator of the local network. The charging station should be in the same IP range as the energy meter.
 - e. IP address meets the requirements of the IPv4 protocol. IPv6 address are not supported by the Alfen charging station.
 - f. Access to settings of the local network for the purpose of configuration of the energy meter and charging station (IPv4 address, Subnet Mask, Default Gateway).
 - Network adapter laptop set to automatic IP
 - Open internet connection; FTP server should be accessible to receive updates and feature keys from
 - Disabled blocking firewalls on laptop
 - Modbus messages:
 - Modbus master should connect to IP of the Modbus slave's wired Ethernet connection on port 502
 - All communication must be in Big Endian format

5. ACTIVE LOAD BALANCING

- Configuration tool: Alfen ACE Service Installer, **version 2.3.4** and higher
- Valid account for Alfen ACE Service Installer (can be requested via <https://support.alfen.com>)
- Keep alive timeout of 60 second before the connection with a Modbus master is closed when no new read or write message is received.
- To serve electric vehicles which require a minimal charging current of 14A, a minimum charging current of 14A is required.
- If configuring a Modbus TCP/IP energy meter that is not pre-configured in the ACE Service Installer, it must be known for the custom register mapping which registers are used in the energy meter for the actual currents phase L1, L2 and L3

5.3.1.3 Requirements ALB via Energy Management System

To ensure a proper working of the Active Load Balancing feature via an EMS, the following requirements should be met:

- The Alfen charging station is updated with firmware **version 4.2.0** (or higher).
- The Alfen charging station is equipped with an activated Active Load Balancing feature
- Communication cable: CAT5e or CAT6 UTP/Ethernet RJ45 cable, cable tracé max. 100m
- Supporting Modbus TCP/IP; the EMS will assume the role of the Modbus 'master' in this configuration. The charging station acts as a 'slave'.
- Network:
 - a. The charging station is located in the same local network as the energy meter or Energy Management System
 - b. Network with a minimum speed of 10Mbps
 - c. No power over Ethernet
 - d. The EMS can find the IP-address of the charging station via the mDNS protocol or the charging station is set to a fixed IP-address.
 - e. IP address meets the requirements of the IPv4 protocol. IPv6 address are not supported by the Alfen charging station.
 - f. Access to settings of the local network for the purpose of configuration of the energy meter and

charging station (IPv4 address, Subnet Mask, Default Gateway).

- Network adapter laptop set to automatic IP
- Open internet connection; FTP server should be accessible to receive updates and feature keys from)
- Disabled blocking firewalls on laptop
- Modbus messages:
 - Modbus master should connect to IP of the Modbus slave's wired Ethernet connection on port 502
 - Requests with certain slave addresses are accepted, where charging station related Modbus registers require slave address 200 and socket related Modbus registers require slave address 1 or 2, depending on the socket.
 - All communication must be in Big Endian format
- Configuration tool: Alfen ACE Service Installer, **version 3.4.2** and higher
- Valid account for Alfen ACE Service Installer (can be requested via <https://support.alfen.com>)
- Validity time of 60 seconds (configurable) before the station will be set back to safe current. The EMS should update the socket current/SCN total current setpoint within the validity time, else the charging station(s) will be set back to the set safe current.
- The EMS must integrate the Alfen charging station. Please use the document Implementation of Modbus Slave TCP/IP for Alfen NG9xx platform with applicable registers for this implementation.
- To serve electric vehicles which require a minimal charging current of 14A, a minimum charging current of 14A is required.

5.3.2 Ethernet connector

Connect the smart energy meter to the charging station (or Smart Charging Network) via the switch/router of the local network.

Depending on the charging station:

- The Ethernet connector is located on the controller of the charging station
- The Ethernet cable can be connected to the RJ45 connector on the casing of the charging station (Eve Double charging stations)



Figure 5.15: Ethernet connector locations

5.3.3 Configuration of Active Load Balancing

The configuration of the Active Load Balancing functionality can be done via the ACE Service Installer or via a back office system.

Prior to the configuration of the Active Load Balancing functionality, the installation and configuration of the charging station have to be executed as described in the User Manual of the product.

The Active Load Balancing feature should be unlocked before being able to configure the settings.

NOTICE

Unlocking the feature via the ACE Service Installer or a back office is described in the topic [Unlock Smart Charging features](#).

5.3.3.1 Configuration of ALB via the ACE Service Installer

1. Open the ACE Service Installer
2. Select the charging station
3. Select the Smart Charging tab



4. Select the box next to Active Load Balancing. The following parameters will show.



5. Data Source; fill in the type of data source:
 - a. Meter: the connected smart energy meter will communicate the power values to the charging station. Based on these values the charging station will increase or decrease the power on the socket output. Continue with step 6.
 - b. Energy Management System: the customers Energy Management System will communicate dynamic minimum and maximum values to the charging station. Based on these values the charging station will increase or decrease the power on the socket output. Continue with step 9.

Active Load Balancing	<input checked="" type="checkbox"/>
Data Source	Meter
Received Measurements	Include charging EV
Protocol Selection	Modbus TCP/IP
Maximum smart meter current (A)	64
Safe current (A)	7
Phase rotation	L1L2L3

6. Fill in whether the connected smart energy meter includes the currents of the charging station. In case the charging current is included, the charging station will limit the charging current if the other load (e.g. household equipment) demands more power.

Active Load Balancing	<input checked="" type="checkbox"/>
Data Source	Meter
Received Measurements	Include charging EV
Protocol Selection	Modbus TCP/IP
Maximum smart meter current (A)	64
Safe current (A)	7
Phase rotation	L1L2L3

7. Select the energy meter's communication protocol.

Active Load Balancing	<input checked="" type="checkbox"/>
Data Source	Meter
Received Measurements	Include charging EV
Protocol Selection	Modbus TCP/IP
Maximum smart meter current (A)	64
Safe current (A)	7
Phase rotation	L1L2L3

8. Fill in the maximum smart meter current. This is the maximum current the charging stations may distribute if no other appliances draw current from the installation. The actual limit is based on the measurements from the meter.

Active Load Balancing	<input checked="" type="checkbox"/>
Data Source	Meter
Received Measurements	Include charging EV
Protocol Selection	Modbus TCP/IP
Maximum smart meter current (A)	64
Safe current (A)	7
Phase rotation	L1L2L3

9. Fill in the Safe current. This is the current limit that is used by the charging station when the connection between the charging station and the energy meter/ Energy Management System is lost.

5. ACTIVE LOAD BALANCING

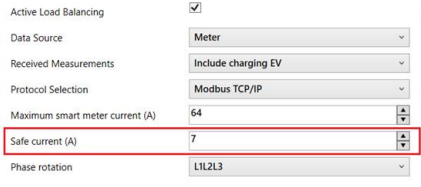

10. If allowed, fill in the phase rotation. Note: this is the sequence of the phases of the feeder cable (to the charging station). There are multiple options depending on the type of charging station and connection.

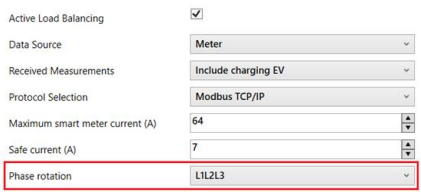

11. Click on Save

12. Click on the power button to reboot the charging station

5.3.3.2 Configuration of a Modbus TCP/IP meter via the ACE Service Installer

Refer to the manufacturer manual of the energy meter on how to configure the energy meter for connecting with the charging station.

1. If Active Load Balancing is enabled and the Modbus TCP/IP is selected (see paragraph Configuration of ALB via the ACE Service Installer) an additional page is shown on the screen. Double click to open the screen.

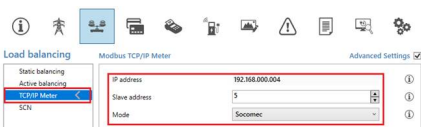

2. Fill in the IP address, Slave address (meter address) and select the meter brand. In case the meter is not a Socomec meter, select Custom register mapping in the drop down and click on Save.

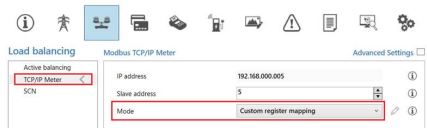

3. The configuration pop-up screen will appear. Configure the required smart energy meter by filling in the register numbers, type (unsigned or signed), size (32 or 64 bit) and scaling factor per phase. Click on Save.

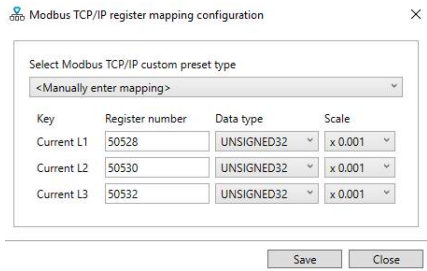

4. When the smart energy meter is configured properly a test can be run by clicking on the button Test Smart Meter. If configured correctly a screen will pop up and show the actual current per phase.

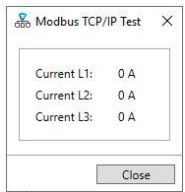

5.3.3.3 Configuration of an EMS via the ACE Service Installer

1. If the Energy Management System is selected as the data source (see paragraph Configuration of ALB via the ACE Service Installer) an additional page is shown on the screen. Double click to open the screen. Select TCP/IP EMS in the menu.

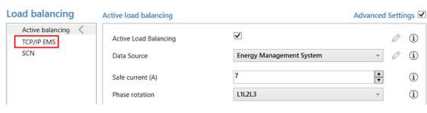

2. Fill in the Mode. Select whether the EMS is managing every single socket or a complete Smart Charging Network).



- Fill in the validity time (default 60s). When the charging station has not received any updates from the EMS within the configured validity time, the charging station will interpret this as a disconnect and will fall back to the configured safe current.



5.3.3.4 Configuration of ALB via a back office system

The Active Load Balancing feature can be configured via a back office. In addition to configuring the settings as described in the steps below, the external data source (smart energy meter or EMS) should be configured. This is described in separate paragraphs.

- Log in to the back office and select the charging station
- Go to the Configuration settings (refresh if needed)
- Configure the following settings:

Parameter (key)	Possible values
Active-LoadBalancing	On Off (default)
SmartCharging-Mode	None (unless the charging station is connected based on OCPP1.5, then this value should be OCPP1.5+)
Station-MaxCurrent	Varies per location
Connector1-Max-Current	Depending on the type of charging station
Connector2-Max-Current	Depending on the type of charging station
SmartMeter-Max-Current	Varies per location This is the current limit of the installation. The charging station will make sure not to exceed this limit to avoid an overload situation.
SmartMeterIncludesCharger	True False

Parameter (key)	Possible values
Safe-MaxCurrent	Float
Phase-Connected	L1, L2, L3, L1L2L3, L1L3L2, L2L3L1, L2L1L3, L3L1L2, L3L2L1

- Reboot the charging station

5.3.3.5 Configuration of a DSMR P1 meter via a back office

NOTICE

Prior to configuring a DSMR P1 meter via a back office the Active Load Balancing feature should be configured correctly. Refer to paragraph Configuration of Active Load Balancing via a back office for more information.

When using a (D)SMR P1 meter in the setup, the following settings have to be set correctly:

Parameter (key)	Possible values
RJ11-Mode / DirectExternalSuspendSignal	DSMR P1 Suspend when an external circuit is closed Suspend when an external circuit is opened
ALB-ProtocolSelection	DSMR4.x/SMR5.0 (P1) Modbus TCP/IP

- Fill in DSMR P1 at RJ11-Mode/ DirectExternalSuspendSignal
- Fill in DSMR4.x/SMR5.0 (P1) at ALB-ProtocolSelection
- Reboot the charging station

5.3.3.6 Configuration of a Modbus TCP/IP meter via a back office

NOTICE

Prior to configuring a Modbus TCP/IP meter via a back office the Active Load Balancing feature should be configured correctly. Refer to paragraph Configuration of Active Load Balancing via a back office for more information.

5. ACTIVE LOAD BALANCING

To configure a smart energy meter supporting the Modbus TCP/IP protocol via a back office, the following settings should be configured:

Parameter (key)	Possible values
ALB-ProtocolSelection	Modbus TCP/IP DSMR4.x/SMR5.0 (P1)
MBTCPSSmart-IsEnabled	True False (default)
MBTCPSSmart-SlaveMeterModel	None Socomec (default)
MBTCPSSmart-ConnectionType	- TCP master (default) - RTU master - UDP master
MBTCPSSmart-IPAddress	192.168.000.005 (default)
MBTCPSSmart-SlaveUnitID	From 0 to 65535 5 (default)

1. Enable the smart meter functionality by setting the MBTCPSSmart-IsEnabled setting to True
2. Fill in the right smart energy meter type at MBTCPSSmart-SlaveMeterModel. Note: the Socomec meter is the only option here. If a different type of meter is integrated in the setup the energy meter should be configured via the ACE Service Installer
3. Fill in the right connection type at MBTCPSSmart-ConnectionType
4. Fill in the Modbus address of the smart energy meter at MBTCPSSmart-IPAddress
5. Fill in the Unit ID at MBTCPSSmart-SlaveUnitID
6. Reboot the charging station

5.3.3.7 Configuration of an EMS via a back office

NOTICE

Prior to configuring an EMS via a back office the Active Load Balancing feature should be configured correctly. Refer to paragraph Configuration of Active Load Balancing via a back office for more information.

When a charging station is controlled by an EMS, the following settings should be configured:

Parameter (key)	Possible values
MbsSlaveTCPIP	On Off (default)
MbsSlaveTCPIPValidity-Time	60s (default)
MbsSlaveTCPIPMode	Off Socket SCN

NOTICE

In case a Smart Charging Network (SCN) is controlled by an EMS, one of the charging stations in the SCN should be configured as described in the procedure below. This charging station will report the available charging current to the rest of the SCN.

1. Set the configuration setting MbsSlaveTCPIP to ON
2. Fill in the required validity time in the MbsSlaveTCPIPValidityTime setting. The EMS should communicate the available charging current for the charging station/SCN within the set validity time
3. Determine whether the EMS should manage the available power for each socket or for the entire Smart Charging Network
4. Reboot the charging station

5.3.4 Verification and testing ALB

It is advisable to verify the working of the Active Load Balancing feature to ensure that the data of the external smart energy meter or energy management system correctly reaches the charger.

NOTICE

It is not possible to use a test plug and another electrical device (any other than an electric vehicle) to verify the working of smart charging functionalities. Other devices, besides electric vehicles, do not respond conform the Mode 3 protocol and will therefore not adjust their drawn current.

5.3.4.1 Verification of ALB with a smart energy meter

In order to verify the working of Active Load Balancing with a smart energy meter, follow the steps below:

1. Perform the installation and configuration as instructed in this document. Make sure the energy meter measures actual current (meaning at least one device). Make sure that during the test the maximum smart meter current is set lower than the sum of the maximum current for the vehicle and the current for other devices connected to the smart energy meter, otherwise Active Load Balancing will not occur. You may temporarily lower the maximum smart meter current for the purpose of testing.
2. Go to the Live monitoring tab and verify if the displayed smart energy meter currents (as shown in the image below) are correct. Tip: use a clamp meter to verify this.

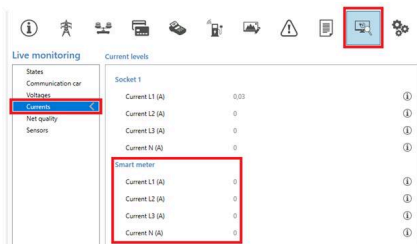

If the displayed values are 0, but the clamp meter registers different values, please check your installation and/or check the paragraph General error handling for more information.

3. Connect one vehicle and start a transaction.
4. Go to the Live monitoring tab, select Currents and observe the drawn currents as shown below:

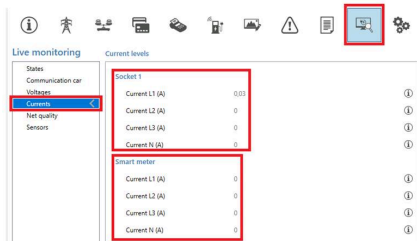

5. After the probing stage of one minute, the currents from the smart energy meter and the electric vehicle are shown. If the setup excludes the EV charging within the smart energy meter measurements, the sum of the smart meter and socket current(s) will amount to the maximum smart meter current in total.
6. Switch on some other connected appliances to monitor whether the smart energy meter current readings increase and the power drawn by the EVs decreases.
7. After testing make sure to set the configuration back to the correct values.

Via these readings it is possible to verify if the phase sequence is as expected. If the EV draws power from L1 but the smart energy meter registers an increase on one of the other phases, this might be an indication for a wrongly installed setup. Refer to the chapter General error handling for more information.

5.3.4.2 Verification of ALB with an EMS

In order to verify the working of Active Load Balancing with an energy management system, follow the steps below:

1. Set up the installation configuration as instructed in this document.
2. Go to the Live monitoring tab, select States and observe the status of the Modbus TCP/IP Connection State as shown below:

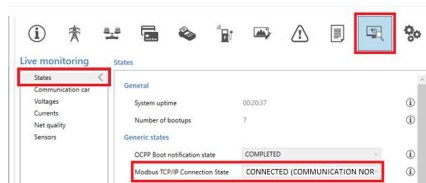

If this state shows Not in use (communication idle), there is a communication loss. Please check your installation or check paragraph General error handling for more information.

3. Connect a vehicle and start a charging session
4. Use the EMS to change the maximum available power. The way to do this differs per EMS. Refer to the manufacturer manual of the EMS for more information.
5. Go to the Live monitoring tab, select Currents and observe the drawn currents.

6. SMART CHARGING NETWORK

6.1 Smart Charging Network

The Smart Charging Network (SCN) is a solution where multiple charging stations are connected to each other via LAN to manage the power distribution locally. For every outlet used, the network decides how fast it can charge, taking the total load into account. To achieve this, all connected charging stations exchange data on the current charging capacity for all users.

If one charging station in an SCN loses connection with the other charging stations, the respective charging station will fall back to the configured safe current.

When the SCN functionality is correctly commissioned, the charging stations recognize each other within the same local network. The total amount of power at the point of interest (which is the point in the installation needed to protect from overload) is divided over the connected sockets based on the configured settings. The parameters to configure before use are:

- Maximum current value grid connection
- Maximum current value of the charging station
- Maximum current value per socket (applicable for multi socket charging stations)
- Safe current value
- Alternating period

In addition to these settings other parameters should be set as well, e.g. in case when Active Load Balancing is combined with an SCN to dynamically manage the power distribution for the SCN.

NOTICE

Configuring the Active Load Balancing feature with an external data source is described in the paragraph Configuration of Active Load Balancing. This can be combined with the configuration of an SCN as described in the paragraph Configuration of a Smart Charging Network.

The SCN decides, based on several parameters, how the total power is divided over the connected EVs in the SCN. When charging stations with two sockets are applied to the SCN, the SCN takes into account that the total amount of charging current on the charging station will never exceed the maximum charging station current.

6.1.1 Scenarios SCN

The Smart Charging Network can be executed in different setups, e.g. single phase network, 3 phase network, in combination with Active Load Balancing, etc.

In the next paragraphs several scenarios are described.

6.1.1.1 Scenarios 1 phase SCN

In a situation where load balancing between SCN and an external load (e.g. a building) is applied, the SCN will respond the same to the data of the applied measuring device as in the Active Load Balancing scenario's described in the ALB section.

NOTICE

When an electric vehicle connects to an Alfen charging station, the charging station starts a so called 'probing phase'. In this phase the charging stations detects whether the electric vehicle requires a minimal charging current of 6A (according to the IEC 61851 norm) or 14A. More information on the probing phase is specified in the topic Probing phase.

The following scenario is written as an example for a situation with an SCN connected to a single phase installation. The available power is divided over the sockets in the SCN. This is a rough schematic representation as the power distribution depends on many factors, e.g. maximum current value per charging station or socket, safe current value, etc.

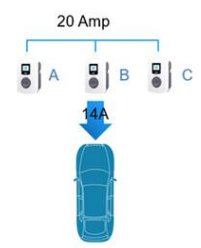
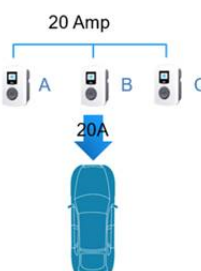
Scenario	Description
	<ul style="list-style-type: none">• EV connected on charging station B• Charging station starts probing phase; charging current 1x14A
	<ul style="list-style-type: none">• After one minute probing phase; EV with minimum charging current of 6A is detected• The maximum power (4,6kW/20A) is allocated to socket B

Scenario **Description**

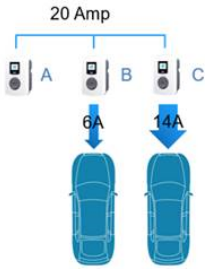

- An EV connects to socket C of the SCN
- Probing phase starts on socket C
- Remaining power (6A) is allocated to socket B

Scenario **Description**

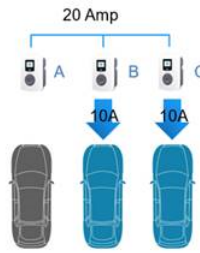

- After probing an EV with charging current of 6A is detected
- All connected EVs will be charged alternately

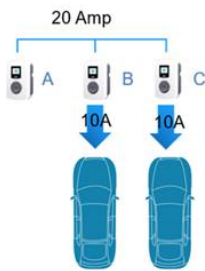

- After one minute probing phase; EV with minimum charging current of 6A is detected
- The available power is divided over socket B and C (2,3kW/10A each)

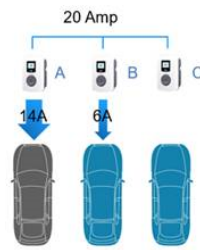

- Every time the EV on socket A is charged, the charging current will be 14A, the remaining charging current is allocated to one of the other EVs based on the alternating principle

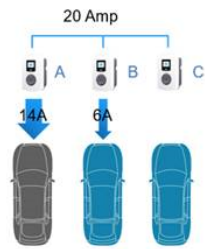

- An EV connects to socket A
- Probing phase starts on socket A
- The remaining power is not enough to divide over the remaining two sockets (B and C). Both sockets will be powered alternately

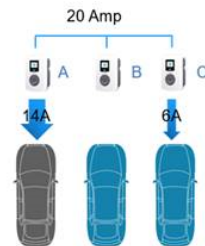

- After one minute probing phase; electric vehicle is detected as EV which requires a minimum of 14A charging current.
- All connected vehicles will be powered alternately.

6.1.1.2 Scenarios 3 phase SCN

The following scenarios are written for a situation with an SCN connected to a three phase grid connection. The available power is divided over the charging stations in the SCN depending on the applied phase connection (changed sequence per charging station) and the connected load (1, 2 or 3 phase EVs).

This is a rough schematic representation as the power distribution depends on many factors, e.g. maximum current value per charging station or socket, safe current value, etc.

6. SMART CHARGING NETWORK

Scenario **Description**

- EV connected to charging station B
- Charging station starts probing phase; charging current 3x14A

- After one minute probing phase; EV with minimum charging current of 6A is detected
- The maximum power (4,6kW/20A) is allocated to socket B

- An EV connects to socket C of the SCN
- Probing phase starts on socket C
- Remaining power is allocated to the EV on socket B

- After one minute probing phase; EV with minimum charging current of 6A is detected
- The available power is divided over socket B and C (2,3kW/10A each)

Scenario **Description**

- An EV connects to socket A
- Probing phase starts on socket A
- Depending on the phase sequence and the type of vehicle (1, 2, or 3 phase EV) the load will be divided over the remaining two sockets (B and C). This is explained in the paragraph Phase sequence

- After one minute probing phase; EV with minimum charging current of 14A is detected
- All connected vehicles will be powered alternately

- The EV with minimum charging current of 14A while the other vehicles are being charged

- Every time the EV on socket A is charged, the charging current will be 14A, the remaining charging current is allocated to one of the other EVs based on the alternating principle

6.1.1.3 Active Load Balancing and SCN

In the next scenario Active Load Balancing is combined with the SCN feature.

The smart energy meter calculates the available charging current for the SCN (in this case 24A). The available charging current in this example is not sufficient to serve

all sockets in use (minimal charging current 6A per socket). The SCN will start charging alternately. The occupied sockets with the lowest ID numbers will be paused first. This means socket ID0 and ID1 will be paused (for the length of the alternating period). The remaining sockets will get 6A each (24A divided over 4 sockets). When the alternating period is expired socket ID2 and ID3 will be paused and socket ID0 and ID1 will get 6A charging current.

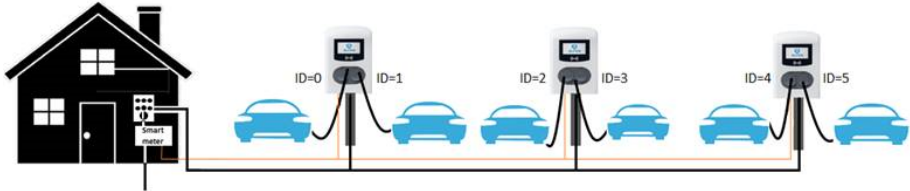

Figure 6.1: Active Load Balancing in SCN

6.1.1.4 Double socket charging stations in SCN

The SCN algorithm treats every socket equally. This means that the SCN decides how much charging current is allocated to a socket.

The Standard Load Balancing in a double socket charging station is therefore overruled by the SCN. The SCN takes into account the configured maximum station current.

Depending on the number of sockets in use the SCN will allocate the available charging current to the charging stations. A double socket charging station will get double the socket current.

In the example below the available charging current is 40A. The available current per socket in use is $40A:4=10A$. The SCN will allocate 20A to the charging station on the left (with two sockets in use), 10A to the charging station in the middle (with one socket in use) and 10A to the single socket charging station on the right.

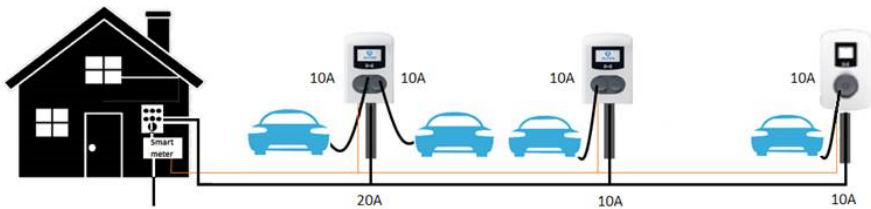

Figure 6.2: SCN with double socket charging stations

6.1.2 Dual feeder cable charging stations in an SCN

In case an SCN is implemented with dual feeder cable charging stations (or a combination with single feeder cable charging stations) the functionality is still the same.

When allocating charging current to the sockets in use the SCN takes into account the configured station max current and connector current.

6. SMART CHARGING NETWORK

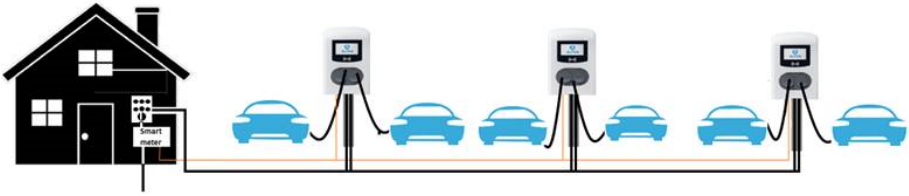

Figure 6.3: SCN with dual feeder cable charging stations

6.1.3 Phase sequence in an SCN

When installing an SCN it is recommended to apply different phase sequences per socket or per feeder cable. Phase mapping is used by the SCN algorithm to determine the available power in the installation. This will benefit the maximum power available per socket.

Based on the phase mapping, the SCN calculates and allocates the amount of power to each socket in the SCN. Applying different phase sequences also prevents uneven load distribution when single EVs are charging on the SCN. The load is divided more equally over the separate phases.

The recommended phase sequence is described in the table below:

NOTICE

Be aware that the recommendations in the table below are examples based on known parameters and can be used as a guideline for the customers location. Installers should be able to select the most optimal connection for the different locations, based on the input given in the table below.

Setup	Charging station type	Internal phase rotation	Recommendation
Smart Charging Network 1 phase (grid) connection, 1 phase charging station	Single socket charging station	n.a.	No phase sequence applicable for single phase connections.
	Double socket charging station (single feeder power supply)	Socket 1: L3L2L1 Socket 2: L1L2L3	
	Double socket charging station (dual feeder power supply)	Socket 1: L3L2L1 Socket 2: L1L2L3	
Smart Charging Network 3 phase (grid) connection, 1 phase charging station	Single socket charging station	n.a.	Socket 1 on L1, socket 2 on L2, socket 3 on L3, socket 4 on L1, etc.
	Double socket charging station (single feeder power supply)	n.a.	
	Double socket charging station (dual feeder power supply)	n.a.	

Setup	Charging station type	Internal phase rotation	Recommendation
Smart Charging Network 3 phase (grid) connection, 3 phase charging station	Single socket charging station	n.a.	Charging station 1: L1L2L3, charging station 2: L3L1L2, charging station 3: L2L3L1 -> continue in this order (charging station 4 starts again with L1L2L3, etc.).
	Double socket charging station (single feeder power supply)	Socket 1: L3L2L1 Socket 2: L1L2L3	
	Double socket charging station (dual feeder power supply)	Socket 1: L3L2L1 Socket 2: L1L2L3	

6.1.3.1 Scenarios phase sequence in an SCN

Below some examples are shown to explain how the power will be divided over the sockets when the advised phase sequence is applied.

Case 1:

In this case all connected EVs are single phase EVs. Due to the phase sequence in the SCN every EV is charged with the most optimal charging current (in this example 20A).

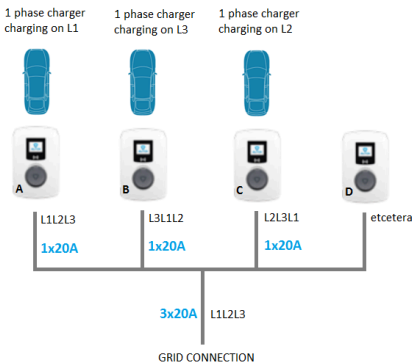

Figure 6.4: Single phase EVs connected to SCN, optimal charging current

Case 2:

In this case a 2 phase EV is connected to the SCN together with a single phase EV. Due to the phase sequence in the SCN every EV is charged with the most optimal charging current (in this example 20A per phase).

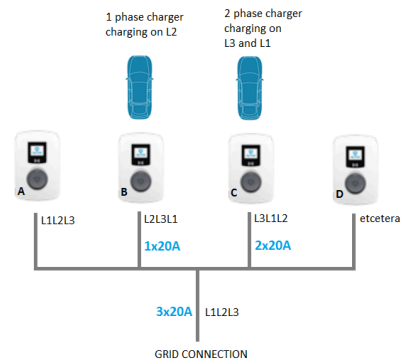

Figure 6.5: 2 phase EV connected to an SCN, optimal charging current

Case 3:

In this case a 2 phase EV is connected to the SCN in combination with a single phase EV. However, both EVs charge on the same phase (L1 in this example). Due to the overlapping phase, the charging current is divided over the two EVs. This means the EVs will not be charged with the most optimal charging current.

If the charging current is not sufficient to serve both EVs, the EVs will be charged alternately.

6. SMART CHARGING NETWORK

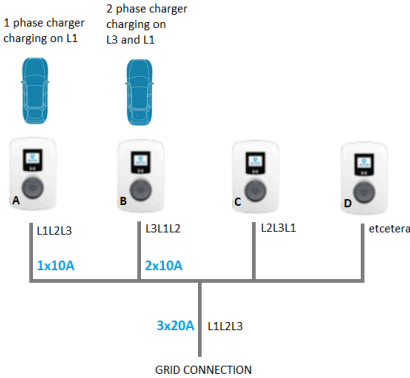

Figure 6.6: 2 phase EV connected to an SCN, reduced charging current

Case 4:

In this case a 3 phase EV is connected to the SCN in combination with a single phase EV. However, both EVs charge on the same phase (L1 in this example). Due to the overlapping phase, the charging current is divided over the two EVs. This means the EVs will not be charged with the most optimal charging current.

If the charging current is not sufficient to serve both EVs, the EVs will be charged alternately.

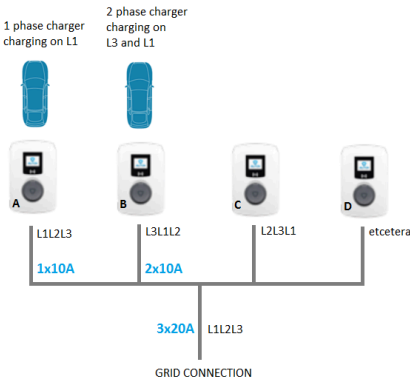

Figure 6.7: 3 phase EV connected to an SCN, reduced charging current

6.2 User interface

When Standard Load Balancing is active, this is shown via either the LED or the display on the charging station.

Display status: the display will show the adjusted power.

NOTICE

Be aware that in case the charging current is decreased, the charging capacity (A) will not meet the maximum charging capacity of the socket (B).

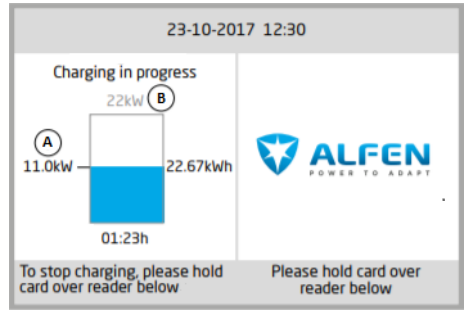

Figure 6.8: Display charging station

LED status; there are two possible situations:

- The status LED flashes dark blue: the charging station requests the first EV to reduce the charging speed so that the power can be divided over the two connected EVs;
- The status LED flashes light blue: the charging process of the second EV will be started as soon as the other EV has adjusted the charging speed. When only one of the EVs can be charged at a time, the LED will alternately flash light blue. The available power is divided over both EVs by charging alternately every 15 minutes. When this indication is shown, charging is currently paused and will resume within 15 minutes (configurable setting).

6.3 Installation

6.3.1 Requirements SCN

To ensure a proper working of the Smart Charging Network, it is advised to meet the following requirements:

- The Alfen charging stations are operating on **the same** firmware version, **at least version 3.4.0**. Preferably the latest version; information can be obtained via <https://alfen.com/en/downloads>.
- The Alfen charging stations have the Smart Charging Network feature unlocked
- Configuration tool: Alfen ACE Service Installer, **version 2.3.0.96** and higher. Preferably the latest release; available via <https://alfen.com/en/downloads>.
- Configuration device (laptop) provided with a Windows operating system
- Valid account for Alfen ACE Service Installer (can be requested via <https://support.alfen.com>)

- To serve electric vehicles which require a minimal charging current of 14A, at least 14A should be available.
- Minimum of 2 charging stations in an SCN
- Applied phase sequence as recommended in paragraph Phase sequence in an SCN
- All charging stations are in the same network (subnet, IP range); by default, this is 169.254.x.x
- All charging stations are configured with one exactly identical smart charging network name
- The SCN name should not contain special characters. Only use A-Z and 0-9, with a maximum of 7 characters.
- CAT5 or CAT6 UTP/Ethernet cable, cable tracé max. 100m per individual Ethernet cable. The range can be extended with another 100m by using a switch.
- Network with a minimum speed of 10Mbps
- No power over Ethernet
- UDP port: 36549, inbound-outbound
- Use a DHCP server (router); without a DHCP server, the charging stations obtain an IP address via Auto-IP
- Network adapter laptop set to automatic IP
- Open Internet connection; Alfen update server should be accessible to receive updates and feature keys from)
- Disabled blocking firewalls on laptop
- All charging stations are fed from the same power supply point; each charging station is fitted with an individual fuse
- A LAN (preferably DHCP) should be available with at least the amount of ports available to connect with all the charging stations in the SCN.
 - Use the star network topology; looping through of the feeder cables and data cables from charging station to charging station is not possible.
 - Tip: Always make sure one port is available on the switch to connect a laptop with the ACE Service Installer. Otherwise, make sure the laptop is in the same subnet as the charging stations.
- Maximum of 128 sockets in one SCN



Figure 6.9: Charging stations in SCN connected to a switch/router

6.3.2 Installing a Smart Charging Network

When installing an SCN observe the following recommendations:

1. Power connection; for the installation procedure of a charging station refer to the User Manual or the Quick Installation Guide of the product. Each charging station should be fitted with its own fuse and Residual Circuit Device (RCD) (in case the RCD is not integrated in the

charging station). The electrical components can be placed in the (separate) distribution cabinet. Refer to local standards and regulations, these might differ per country.

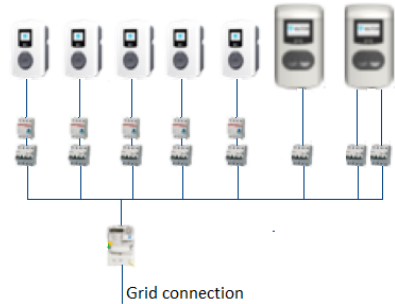

2. Phase sequence; by applying a different phase sequence on the charging stations in the SCN the available power can be utilized optimally. See paragraph Phase sequence for more info.
3. Data connection; every charging station in the SCN has to be part of the same local network. Therefore the charging stations must be connected to a switch/router in a star network topology. When the connection with one charging station is lost, the other stations will still be working. Looping through from charging station to charging station is not supported.

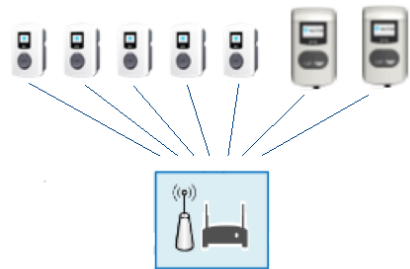

Local Area Network

4. Smart energy meter/EMS connection; a maximum of one smart energy meter/EMS can be connected to the SCN. The smart energy meter/EMS has to be connected to one or multiple charging stations in the SCN. The smart energy meter has to be placed on the point of interest in the installation.

6. SMART CHARGING NETWORK

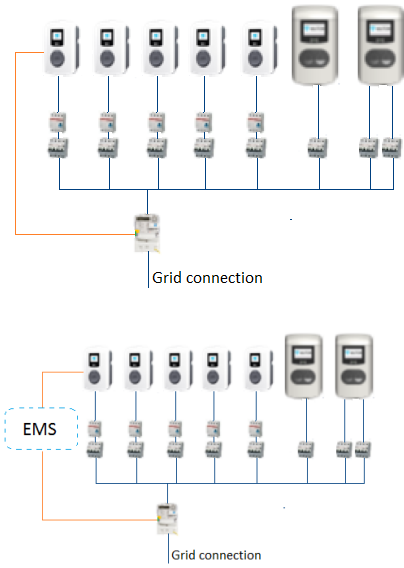

5. Test the LAN by pinging the charging stations via the CMD console on the computer. Bad wiring can be identified by high latency/latency fluctuations (time = Xms should be consistent). Tip: stress the network cable (especially close to the RJ45 connectors) during an ongoing ping session (ping xxx.xxx.x.x-t and press Ctrl + c to stop).

```

Opdrachtprompt
C:\Users> >ping 192.168.1.106 -t

Pinging 192.168.1.106 with 32 bytes of data:
Reply from 192.168.1.106: bytes=32 time=2ms TTL=255
Reply from 192.168.1.106: bytes=32 time=2ms TTL=255
Reply from 192.168.1.106: bytes=32 time=2ms TTL=255
Reply from 192.168.1.106: bytes=32 time=2ms TTL=255
Reply from 192.168.1.106: bytes=32 time=2ms TTL=255
Reply from 192.168.1.106: bytes=32 time=2ms TTL=255
Reply from 192.168.1.106: bytes=32 time=2ms TTL=255
Ping statistics for 192.168.1.106:
    Packets: Sent = 8, Received = 8, Lost = 1 (12% loss),
    time=2ms Approximate round trip times in milli-seconds:
        Minimum = 2ms, Maximum = 2ms, Average = 1ms
TTL=255
Control C
  
```

6. Make sure to note the applied phase mapping of the installation

6.3.3 Configuration of a Smart Charging Network

NOTICE

Unlocking the feature via the ACE Service Installer or a back office is described in the topic Unlock Smart Charging features.

6.3.3.1 Create a new SCN via the ACE Service Installer

This paragraph describes how to create a new SCN and how to add charging stations to an SCN.

NOTICE

When configuring a new SCN the related charging stations should already be visible in the ACE Service Installer (check the LAN by pinging the charging stations). This means the charging stations have to be installed and added to the same local network. Check for installation details the Original User Manual of the product. Network requirements are specified in the Requirement section of the Smart Charging Network chapter in this document.

To configure a new SCN, do the following:

1. Verify if the SCN feature is unlocked (if not, refer to paragraph (Unlock features via the ACE Service Installer)
2. Open the ACE Service Installer
3. Select a charging station which has to be added to the new SCN

ACE Service Installer

File Device Reports Tools Help



4. Click on Device and Add to new SCN

6. SMART CHARGING NETWORK

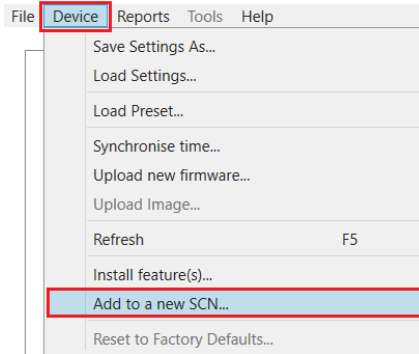

- The following screen will appear. Fill in a name for the SCN and click OK. The SCN name should not contain special characters. Only use A-Z and 0-9, with a maximum of 7 characters.

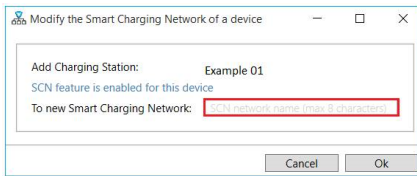

- Refresh the overview of charging stations by clicking the Refresh button at the bottom left of the ACE Service Installer screen. In some cases it might be necessary to restart the ACE Service Installer to make the new SCN visible in the menu.



- Select the new SCN and click on the SCN Overview button. This will show all the charging stations in the SCN.

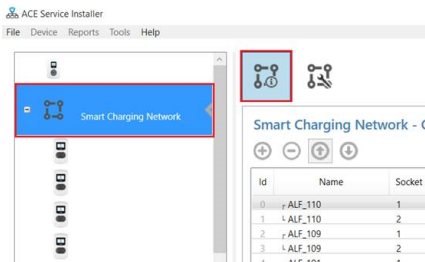

- Use the Add a new charging station button to add charging stations to the SCN. Select a charging station in the pop-up screen and click OK. The charging station will be automatically rebooted.

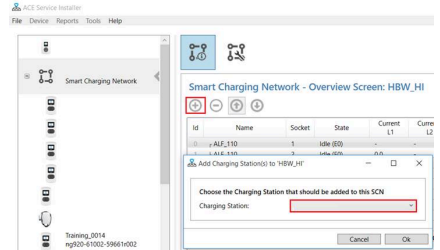

- If, after adding all the charging stations to the SCN, a charging station is still not visible in the overview of the SCN, reboot the ACE Service Installer.

6.3.3.2 Configure SCN settings via ACE Service Installer

- Open the ACE Service Installer
- Select an SCN and select the SCN Settings screen button. The setting screen will appear:

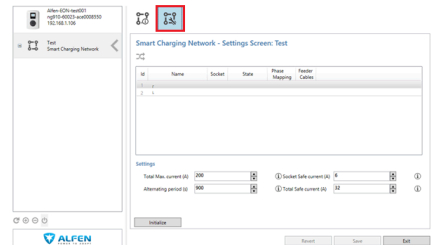

- Select a charging station and click on the phase mapping button. Fill in the number of feeder cables from grid connection to the charging station and select the right phase sequence in the drop down. Refer to paragraph Phase sequence in an SCN. Repeat this for every power feeder cable in the SCN. Be aware that the socket ID will be assigned (in the Initialize step) based on the order the charging stations are added to the SCN.

6. SMART CHARGING NETWORK

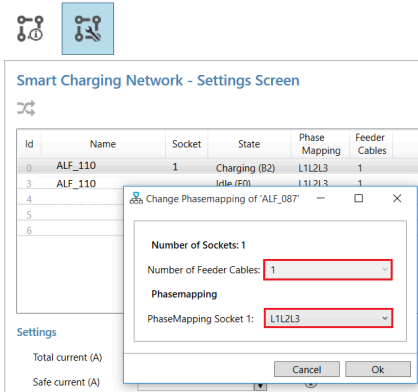

6.3.3.3 Configure charging station for SCN via ACE Service Installer

NOTICE

The SCN will calculate the Socket count based on the configuration settings of the added charging stations. It is very important to set all specified settings correctly.

NOTICE

Always initialize the SCN after changing SCN related configuration settings!

4. Fill in the required settings of the SCN.

Parameter	Description
-----------	-------------

Total Max. current (A)	Total capacity for all charging stations combined.
-------------------------------	--

Altering period (s)	Alternation period (pause) in the event of insufficient capacity. When the sum of all minimum charging currents is higher than the available current for the SCN, the SCN will alternate the sockets between charging and pausing.
----------------------------	--

Default 900s. Electric vehicles allow alternating periods with a minimum of 60s.

Socket Safe current	Available power reserved for each socket when the connection of a charging station with the SCN is lost. This value should always be identical for all the sockets in the SCN.
----------------------------	--

Total safe current (A)	Available power reserved for the whole SCN when the SCN loses connection with the smart energy meter (SCN + ALB). If ALB is not used, configure Total safe current = Total Max. current.
-------------------------------	--

5. Click the Initialize button. This will push the configured values (step 4) to all charging stations in the SCN. The socket ID is assigned based on the order the charging stations are added to the SCN. This will also be executed when clicking the Initialize button.

1. Open the ACE Service Installer

2. Select the charging station to be configured and click on the Power settings button

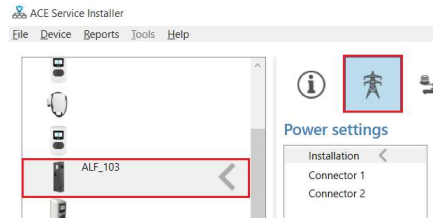

3. Select the option Installation and fill in the Station maximum current (A). This is the maximum current that the entire charging station is allowed to provide, this is also used for Standard Load Balancing in double socket charging stations.



Note: a double socket charging station is used in this example. When you configure a single socket charging station, some of the configuration items will not be shown as they are not applicable.

- Select the Connector option and fill in the Max current (A). This is the maximum allowed current the socket can provide based on the type of charging station and the maximum available current. Repeat this step for the second connector if applicable.



- Select the Load balancing tab and select SCN. Fill in the Safe Current (A) value. This is the available power reserved for a socket when the charging station loses connection with the SCN. Alfen advises to set a value >6A. Note: the safe current does not have to be set per individual charging station when connected to a LAN while configuring. Then the Socket Safe Current (SCN setting) will be applied to all sockets in the SCN when initialized.

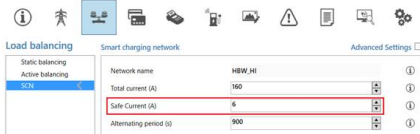

To configure an SCN and related charging stations via a back office, do the following:

- Log in to the back office and select the desired charging station
- Go to the configuration settings. Verify if the SCN feature is unlocked via the setting UnlockedFeatures. Refer to paragraph Unlock features via a back office for the unlock procedure.
- Go to SCN-IsEnabled and configure the value True.
- Go to SCN-NetworkName and configure the desired name for the SCN. The network name can contain characters A-Z and 0-9 with a maximum of 7 characters. The network name needs to be identical for all charging stations in one SCN.
- Go to SCN-SocketID and configure the correct ID value. This is the number of the socket in the site setup. Always start with value '0', then '1', and so on. The socket ID value is used when the SCN-TotalSafeCurrent is activated. The occupied charging station with the lowest ID number will get priority. Each socket in an SCN should have a unique ID value. Range 0-128.
- Go to SCN-TotalStaticCurrent. This is the available static power for the whole SCN. Configure the correct value.
- Go to SCN-SocketSafeCurrent. This is the available power reserved for a socket when the charging station loses connection with the SCN. Configure the correct value (default 6A).
- Go to SCN-AlternatingPeriod. In case the available power in an SCN is insufficient to serve all sockets in use, the charging EVs will be charged alternately. Part of the charging sessions will be paused for the length of a set alternating period, whilst other charging sessions will be resumed. Configure the desired value (default 900s). Possible range 60-36000s.
- Configure the following settings:

NOTICE

If a charging station is added to a commissioned SCN (in use for a longer period of time), the SCN will automatically adjust the Socket count setting, but only if the charging station is added to the SCN via the Add to SCN button.

6.3.3.4 Configure SCN and charging station via a back office

NOTICE

Configuration of an SCN via a back office is very much prone to errors, but theoretically possible. Alfen recommends to configure the SCN and charging stations via the ACE Service Installer.

NOTICE

Be aware that when a charging station needs to be added to an existing SCN in a later stage, the SCN-SocketCount setting on all charging stations has to be updated. Reboot each charging station after the update.

6. SMART CHARGING NETWORK

Setting	Description	Value
Station-Max-Current	The maximum current that the entire charging station is allowed to provide, this is also used for Standard load balancing in double socket charging stations	Depending on the type of charging station
Connector1-MaxCurrent	Maximum current allowed on this socket	Depending on the type of charging station
Connector2-MaxCurrent	Maximum current allowed on this socket. Only applicable for double socket charging stations.	Depending on the type of charging station
SCN-PhaseMapping-1	Phase sequence of socket 1 (feeder cable). For single feeder cable double socket charging stations 'SCN-PhaseMapping-1' (left socket) is identical to 'SCN-PhaseMapping-2' (right socket).	1=L1 2=L2 3=L3 4=L1L2L3 5=L1L3L2 6=L2L1L3 7=L2L3L1 8=L3L1L2 9=L3L2L1
SCN-PhaseMapping-2	Phase sequence of socket 2 (feeder cable)	0= no socket (for single socket charging stations) 1=L1 2=L2 3=L3 4=L1L2L3 5=L1L3L2 6=L2L1L3 7=L2L3L1 8=L3L1L2 9=L3L2L1

10. Go to SCN-SocketCount. This is the total amount of sockets in the SCN. Configure the correct value.

NOTICE

If a charging station is added to a commissioned SCN (in use for a longer period of time), the Socket count setting needs to be updated to the new amount of sockets in the SCN. Via a back office it is mandatory to change the Socket count setting on each charging station individually. It is recommended to add the new charging station to the SCN via the ACE Service Installer. Than the Socket count setting will be updated automatically (but only if the charging station is added to the SCN via the Add to SCN button).

6.3.4 Verification

When an SCN is properly installed and configured the working of the system can be validated by checking the response messages via ACE Service Installer or via the back office.

NOTICE

It is not possible to use a test plug and another electrical device (any other than an electric vehicle) to verify the working of smart charging functionalities. Other devices, besides electric vehicles, do not respond conform the Mode 3 protocol and will therefore not adjust their drawn current.

6.3.4.1 Verify SCN via the ACE Service Installer

Select the new SCN and click on the Overview button. The overview will show all the charging stations in the SCN, the sockets currently in use (state) and the load per phase (Current).

ID	Name	Socket	State	Current E1	Current E2	Current E3	Check	Info
1	FW020112	1	Idle (E5)	0.0	0.0	0.0	OK	15180 - 1500 W, Max 10.00 (E1), 0.00 (E2), 0.00 (E3) (E5)
2	FW020112	2	Charging (E2)	0.0	0.0	0.0	OK	15180 - 1500 W, Max 10.00 (E1), 0.00 (E2), 0.00 (E3) (E5)
3	A42_387	1	Idle (E5)	0.0	0.0	0.0	OK	15180 - 1500 W, Max 10.00 (E1), 0.00 (E2), 0.00 (E3) (E5)
4	A42_371	1	Idle (E5)	0.0	0.0	0.0	OK	15180 - 1500 W, Max 10.00 (E1), 0.00 (E2), 0.00 (E3) (E5)
5	A42_373	2	Idle (E5)	0.0	0.0	0.0	OK	15180 - 1500 W, Max 10.00 (E1), 0.00 (E2), 0.00 (E3) (E5)
6	FW020115	1	Idle (E5)	0.0	0.0	0.0	OK	15180 - 1500 W, Max 10.00 (E1), 0.00 (E2), 0.00 (E3) (E5)
7	FW020115	2	Idle (E5)	0.0	0.0	0.0	OK	15180 - 1500 W, Max 10.00 (E1), 0.00 (E2), 0.00 (E3) (E5)
8	A42_390	1	Idle (E5)	0.0	0.0	0.0	OK	15180 - 1500 W, Max 10.00 (E1), 0.00 (E2), 0.00 (E3) (E5)
9	A42_390	2	Charging (E2)	3.3	0.0	0.0	OK	15180 - 1500 W, Max 10.00 (E1), 0.00 (E2), 0.00 (E3) (E5)
10	A42_362	1	Charging (E2)	0.0	0.0	0.0	OK	15180 - 1500 W, Max 10.00 (E1), 0.00 (E2), 0.00 (E3) (E5)
11	A42_362	2	Idle (E5)	0.0	0.0	0.0	OK	15180 - 1500 W, Max 10.00 (E1), 0.00 (E2), 0.00 (E3) (E5)
Total SCN Chargers Usage				3.3 (100.0)	0.0 (00.0)	0.0 (00.0)		

When sockets are disconnected from the network, only the first 10 sockets are able to reach the safe current of 15A.

Buttons: Refresh, Save, Exit

6.3.4.2 Verify SCN via a back office

Verifying the Smart Charging Network feature is possible via a back office only if the back office system setup is configured to interpret and display the required values.

7.1 Smart Charging profiles

With Smart Charging profiles a central system gains the ability to influence the charging power or current of a specific EV, or the total allowed energy consumption on an entire charging station/group of charging stations, for instance, based on a grid connection, energy availability on the grid or the wiring of a building.

Influencing the charging power or current is based on power transfer limits at specific points in time. Those limits are combined in a charging profile.

Alfen charging stations are certified by the Open Charge Alliance to be fully compliant with the OCPP (Open Charge Point Protocol) 1.6 and support all Smart Charging Profiles specified in this protocol. OCPP 1.6 can be downloaded from <https://www.openchargealliance.org/downloads/>. Consult chapter 7.8 from the protocol for more information regarding the charging profiles.

7.2 OCPP Smart Charging parameters

Take notice of the following parameters for the Alfen charging stations:

Parameter	Value
ChargeProfileMaxStackLevel	15
ChargingScheduleAllowedChargingRateUnit	Current
ChargingScheduleMaxPeriods	100
MaxChargingProfilesInstalled	45
OCPPStackVersion	4.7.0

8. SUSPEND CHARGING MODE

8.1 Suspend Charging Mode

In some countries the local energy laws specify the possibility for consumers to use electricity at reduced standing charges if it complies with certain conditions.

The option only applies to customers who have a controllable device containing an independent measuring module (for instance an EV charging station) connected to their domestic energy connection.

To meet the requirements of these laws Alfen developed the Suspend Charging Mode feature.

The Suspend Charging Mode feature also applies to a situation where an external relays is installed which can be used to temporarily halt a charging session. The charging station detects the signal coming from the relays and activates the Suspend Charging Mode sequence.

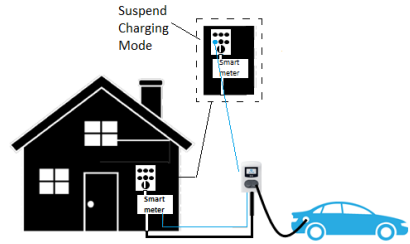

Figure 8.2: Scenario Suspend Charging Mode with potential free contact (energy meter)

NOTICE

The Suspend Charging Mode feature is described in an addendum to the ACE User Manuals; the Suspend Charging Mode installation guide. This document can be downloaded from <https://alfen.com/en/downloads>.

8.2 Scenarios Suspend Charging Mode

The Suspend Charging Mode can be activated in two different scenarios:

- By an external relays in the distribution cabinet (activated in case of a calamity)
- By the grid operator, via a potential free contact in the energy meter (activated in case of an overload on the grid)

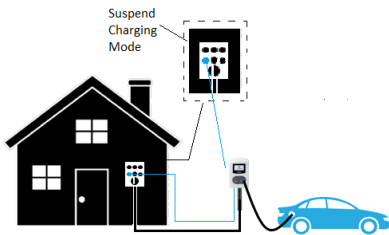

Figure 8.1: Scenario Suspend Charging mode with external relays

9. COMPATIBILITY SMART CHARGING FEATURES

9.1 Compatibility features

This chapter describes the co-operation, inclusion, exclusion and dependency of the Alfen smart charging functionalities.

9.2 Combination

Alfen's Smart Charging features can be combined as shown in the table.

Standard Load Balancing	Active Load Balancing (D)SMR	Active Load Balancing TCP/IP	Smart Charging Network	Suspend Charging Mode
x	x			
x		x		
x	x		x	
x		x	x	
x		x		x
x		x	x	x

⚠ WARNING

Be aware that the Suspend Charging Mode functionality is **not** compatible with a setup including a (D)SMR meter.

💡 NOTICE

The OCPP Smart Charging feature is compatible with any combination of Alfen Smart Charging features.

For all types of Smart Charging the following applies: when different Smart Charging features are combined, the system that provides the lowest limit is leading. Example: if an OCPP 1.6 Smart Charging profile is sent from a back office to a socket in use in an SCN, the charging current request from the Charging profile is compared to the charging current value the SCN allocates to the socket in use. The lowest charging current value is leading and will overrule the other request.

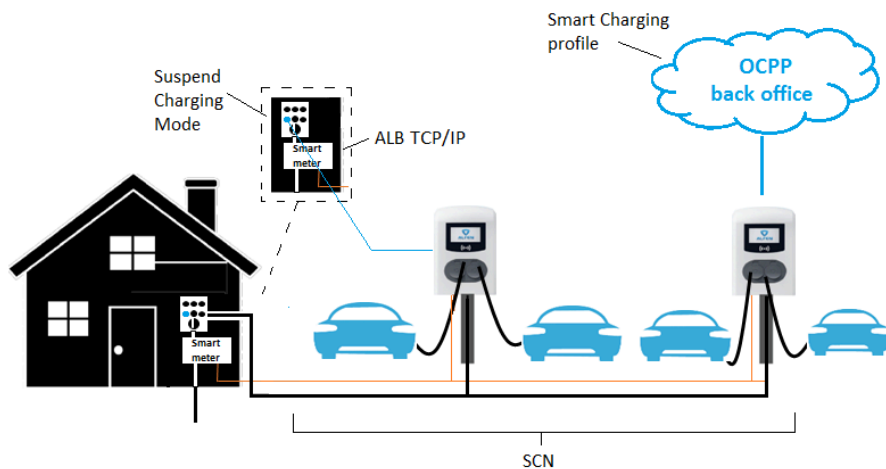

Figure 9.1: Combination of ALB, SCN, Suspend Charging Mode and OCPP Smart Charging profile

The following applies to this scenario:

- When the Suspend Charging Mode is activated, all running charging sessions will be paused.
- The available current measured by the smart energy meter is communicated with the SCN. The SCN divides

the available current over the sockets in use. If the outcome of the SCN (socket current) is lower than the limit from the OCPP Smart Charging profile, the limit calculated by the SCN will be the new limit.

9. COMPATIBILITY SMART CHARGING FEATURES

- If the OCPP Smart Charging profile current value is lower than the outcome of the SCN (socket current), the limit of the OCPP Smart Charging profile will be the new limit.
- If in a setup with ALB the available current insufficient to serve all charging EVs, the SCN will start alternating.

9.2.1 Additional requirements SCN in combination with smart meter P1 port

- Communication cable with RJ11 (using middle 4 contacts) or RJ12 plugs, both straight connected between the charging station that is connected and the smart energy meter
- Maximum communication cable length: 20 meters
- Smart meter:
 - a. Supporting (D)SMR 4.0/eSMR 4.0 (and higher) via P1 port
 - b. Installed on the point of interest in the installation
 - c. Maximum of one Smart meter connected to a charging station

9.2.2 Additional requirements SCN in combination with smart meter TCP/IP

- At least one of the charging stations in the SCN is connected to the smart energy meter. The IP-address of the smart energy meter is configured in the connected charging station.
- The IP-address of the TCP/IP meter needs to be in the same range as the charging stations
- Communication cable: CAT5e or CAT6 UTP/Ethernet RJ45 cable between one charging station in the SCN and the TCP/IP meter, cable tracé max. 100m
- Smart meter:
 - a. Supporting Modbus TCP/IP; at least one charging station will assume the role of the Modbus Master in this configuration. The smart energy meter is the Slave. Note: it is possible to configure multiple charging stations in the SCN to communicate with the TCP/IP meter. In case one of the connected charging stations loses connection with the meter, the other charging stations are still connected (depending on the cause of disconnection).



- b. Maximum of one smart energy meter connected to an SCN
- Network:
 - a. The charging station is located in the same local network as the smart energy meter. The network should be accessible for the purpose of configuration.
 - b. Network with a minimum speed of 10Mbps
 - c. Do not use power over Ethernet

- d. The fixed IP address for the TCP/IP meter is assigned by the network operator of the local network and should be in same IP range as the charging stations
- e. IP address meets the requirements of the IPv4 protocol. IPv6 address are not supported by the Alfen charging station.

- Modbus:
 - Modbus master should connect to IP of the Modbus slave's wired Ethernet connection on port 502
 - The TCP/IP meter should support Big Endian format
- The TCP/IP meter should be able to respond within 60s to prevent invalid connection losses

9.2.3 Additional requirements SCN in combination with EMS

- The Alfen charging station is updated with firmware **version 4.2.0** (or higher).
- Communication cable: CAT5e UTP/Ethernet RJ45 cable (minimum) between SCN and EMS, CAT6 when tracé >100m
- Supporting Modbus TCP/IP; the EMS will assume the role of the Modbus 'master' in this configuration. The charging station acts as a 'slave'.



- Network:
 - a. The charging station is located in the same local network as the Energy Management System and/or smart energy meter. The network should be accessible for the purpose of configuration.
 - b. Network with a minimum speed of 10Mbps
 - c. No power over Ethernet
 - d. IP address meets the requirements of the IPv4 protocol. IPv6 address are not supported by the Alfen charging station.
- Modbus messages:
 - Modbus master should connect to IP of the Modbus slave's wired Ethernet connection on port 502
 - Requests with certain slave addresses are accepted, where charging station related Modbus registers require slave address 200 and socket related Modbus registers require slave address 1 or 2, depending on the socket.
 - The TCP/IP meter and EMS should support Big Endian format
- Configuration tool: Alfen ACE Service Installer, **at least version 3.4.2**. Preferably the latest released version; available via <https://alfen.com/en/downloads>.
- The EMS should update the socket current/SCN total current setpoint within the validity time, else the charging station(s) will be set back to the set safe current.

9. COMPATIBILITY SMART CHARGING FEATURES

- The EMS must integrate the Alfen charging station. Please use the document Implementation of Modbus Slave TCP/IP for Alfen NG9xx platform with applicable registers for this implementation.

9.2.4 Additional requirements SCN in combination with a back office

The functionalities of the Smart Charging Network are available through the UTP/Ethernet connection of the charging stations. This can easily be combined with communication over OCPP, through UTP/Ethernet or GPRS.

Note that you need one SIM card per charging station when using the GPRS option. To limit costs, you can also use a router and a (2G/3G/4G) modem. In that case, the charging stations should be set to communicate with a wired network. The router is then set for the (secure) APN of the relevant management system.

The 4G modem can also be used to build a LAN for the SCN. In that case, the 4G modem must support connection of the SIM-card via the APN of the back office provider. The charging stations will have to connect via a wired connection to the private endpoint because the connection via the APN (possibly also VPN) is established by the 4G modem. This can be configured manually by entering the back office connection settings via the ACE Service Installer. Select Manual enter back office settings under back office preset in the Connectivity tab.

The network operator is responsible to source and set a 4G modem.

The charging stations need to be configured to connect via the wired connection to the 4G modem. From the 4G modem onwards the connection is wireless.

9.2.5 Scenario ALB and OCPP Smart Charging

An OCPP 1.6 back office can send a smart charging profile in any scenario described in this document. If in the scenario below the charging station calculates an available charging current higher than the charging current specified in the OCPP smart charging profile, the value in the smart charging profile will be leading. The back office can act as a limiting factor in this scenario.



Figure 9.2: Scenario ALB and OCPP Smart Charging

In case an OCPP smart charging profile is sent to an SCN, the profile will be sent to an individual charging station. If the charging current value of the profile is lower than the charging current allocated by the SCN for this individual charging station, the lowest value will be leading.



Figure 9.3: Scenario OCPP Smart Charging in an SCN

9.2.6 SCN in combination with Active Load Balancing

In case the SCN feature is used in combination with Active Load Balancing an additional parameter has to be configured:

Setting	Description	Value
SCN-TotalSafeCurrent	Available power reserved for the whole SCN when the SCN loses connection with the smart energy meter (SCN + ALB).	Depending on the power connection.

10. GENERAL ERROR HANDLING

10.1 Troubleshooting

Common issues concerning configuring Smart Charging functionalities and their solutions are described in the next paragraphs.

If the issue is not resolved after consulting the solutions listed or if any other questions arise, please contact our service department through <https://support.alfen.com>.

10.2 Unable to log in to ACE Service Installer

Unable to log in after downloading the ACE Service Installer? Please check the following:

- Downloaded the ACE Service Installer Setup for NG-platform? The Service Installer for Advanced platform only supports older versions of our chargers (produced before mid-2017) and is therefore not applicable.
- Requested a personal account for the ACE Service Installer? Please note that this is a separate account from other Alfen accounts. Request an account through <https://support.alfen.com>. First login with a service portal account (or create one), then go to Configuration tool and fill in the information under Request for account. Personal account details will be send within 1 working day.
- Connected to the internet when opening the ACE Service Installer?
 - After downloading and installing, the installer should always execute an update before logging in. Please make sure to be connected to the internet and install all updates when suggested.
 - If the internet access is restricted, it might not be able to reach Alfen's update (ftp) server. Please refer to paragraph Unable to reach update server for support.

10.3 No internet connection on laptop while connected to the charging station

If there is no connection to the internet while being connected to a charging station/LAN, it is not possible to download updated settings files, new firmware files or update the license key.

Furthermore, it is also not possible to open other applications that require internet connection. When using WiFi to connect to the internet, it must be possible to connect to WiFi as well as the wired network to the charging station at the same time. In this case, please check

- Is there a LAN/WLAN switching service activated on the laptop? Please turn this service off in the laptop via the Windows Task Manager. These settings differ per laptop. Unable to change or find the settings? Please, contact your IT administrator.
- If the WiFi network adapter is set to disable itself when a wired connection is established, please turn this off.

These settings differ per laptop. Unable to change or find the settings? Please contact your IT administrator.

If the above is not workable, use a workaround for obtaining new firmware and settings files from Alfen's update server. Please, disconnect from the charging station, create a WiFi hotspot with a mobile phone, open the ACE Service Installer and accept all updates when asked. When downloaded all files through the open connection from a WiFi hotspot, connect to the charging station again. The laptop will be offline, but the required update files are saved on the laptop. Updating the license key with the Update license key button is not possible via this workaround. Entering the license key code can be done manually.

10.4 Unable to reach update server

Connected to the internet, but still cannot use the functions such as updating the license key or downloading the newest firmware and settings files? Then likely the internet access is restricted and it is not possible to reach Alfen's update (ftp) server. Please check:

- Is Windows Defender Firewall blocking access to Alfen's update server? Open Windows Defender Firewall, go to Advanced settings and make sure the (Inbound/ Outbound) connections for the ACE Service Installer are allowed.
- Is another firewall blocking access to Alfen's update server (port 21)? Please allow access or disable the firewall. For further support, please contact your IT administrator.

10.5 Charging station not visible in the ACE Service Installer

Unable to see the charging station in the ACE Service Installer? The network connection between the laptop and the charging station is not functioning correctly. Note that the Ethernet adapter of the laptop must be in the same range as the IP address of the charging station (by default 169.254.x.x; only if no DHCP server is used and the charging station allocates an IP address to itself). The Ethernet adapter should be in automatic mode and only set to a fixed address if the charging station is configured with a fixed IP-address. Please check the following:

- Is the Ethernet cable in a good condition? Tip: use an Ethernet cable tester to check the condition of your cable. Or test the LAN by pinging the charging stations via the CMD console on the computer. Check paragraph Installing a smart charging network for more information.
- Is the Ethernet network adapter set to obtain an IP automatically? In Windows Network and Sharing Centre, right click on the network adapter and go to Properties. In the list, select Internet Protocol Version 4 (TCP/IPv4) and go to Properties. Make sure the Obtain an IP address

automatically option is selected. This way, the IP address of the network adapter of the laptop will automatically be in the same range as the IP address of the charging station through DHCP server.

- Is the charging station set to a fixed IP and are you unable to find out what IP this is? Alfen recommends labeling with the IP address when setting the charging station to a fixed IP. Please use a network scanner application to search for the charging station. If you are in a large network and you require the MAC address, please request the charging station's FAT report at Alfen's Sales Support department.

10.6 SCN overview and settings not visible in ACE Service Installer

If the individual charging stations are visible, but the charging stations are not visible in the SCN overview, please check the following:

- Is Windows Defender Firewall blocking communication between the ACE Service Installer and the charging stations? Open Windows Defender Firewall, go to Advanced settings and make sure the (inbound-outbound) connections for the ACE Service Installer are allowed for both TCP and UDP.
- Does the SCN name include special characters? Only use A-Z and 0-9, with a maximum of 7 characters.

10.7 Unable to configure smart charging functionality

When configuring a smart charging functionality, the following can be executed to find the necessary configuration parameter(s) in the ACE Service Installer:

- Using a correct version of the ACE Service Installer? Download the newest version at <https://alfen.com/downloads>.
- Is the charging station updated with the correct firmware version? Update the charging station to the newest version by clicking Upload Firmware... in the General tab of the ACE Service Installer.
- Feature unlocked for this charging station? Please, check the features under License key in the General tab of the ACE Service Installer. Is the feature not unlocked? Please, check paragraph Purchase and unlock Smart Charging features on how to purchase and unlock a feature.

10.8 Charging slower than expected

Charging slower than expected during a charging session may be caused by several factors.

Firstly, please verify that the MaxCurrent settings are correct under the Power Settings tab in the ACE Service Installer. Refer to the configuration paragraphs in this document for more information on the different settings.

If the MaxCurrent settings are correct, please check what current the charging station is communicating to the EV. To check the communicated current from charging station to EV, go to the Live Monitoring tab in the ACE Service Installer and select Communication car. Under PWM duty cycle (%), the communicated current is shown. Is this lower than the set MaxCurrent and are you not using any Smart Charging functionalities, please check the following:

- What are the charging specifications of the EV? For instance, if the EV's specifications limit the charging current to 16A, the EV will not charge above 16A.
- What are the specifications of the used charging cable? Some cables only allow 20A charging current and in that case, the charging station will never communicate more current.

Is the charging station communicating the set SafeCurrent of the smart charging functionality that is configured? Then there is a communication loss causing the charging station to use the SafeCurrent. This can be verified by checking the logging. Depending on the setup a warning will be shown:

- (D)SMR: P1 Device failure: Read CRC Error or Unable to start P1 communications, Read Timeout Error and Enter ActiveLB safeMode: x.xA
- TCP/IP meter or EMS: Communication error for modbus unit 502 (<IP address TCMPIP/meter or EMS>;502) and Modbus TCP/IP lost, in safe mode max x.xA and Enter ActiveLB safeMode: x.xA

Refer to the paragraphs dealing with communication loss between charging station and SCN, or charging station/SCN with an external smart energy meter (P1 or TCP/IP) or communication losses with an EMS.

10.9 Charging station loses connection to SCN

If a single charging station is losing connection to the other charging stations within an SCN, the charging station will fall back to the set SocketSafeCurrent per socket. If this occurs, the LiveLog tab in the ACE Service Installer will show an error message as follows: Lost connection with other socket (id: [socket id])!. If this occurs, please check:

- Is the Ethernet cable in a good condition? Tip: use an Ethernet cable tester to check the condition of your cable. Or test the LAN by pinging the charging stations via the CMD console on the computer. Check paragraph Installing a smart charging network for more information.

10.10 Charging station or SCN loses communication with (D)SMR meter P1 port

If the connection to a (D)SMR meter is lost, a charging station or SCN will fall back to the set TotalSafeCurrent

10. GENERAL ERROR HANDLING

for Active Load Balancing. If this occurs during installation, please check the following:

- Is the cable between smart energy meter and charging station in a good condition? Tip: use an Ethernet cable tester to check the condition of the cable. Or test the LAN by pinging the charging stations via the CMD console on the computer. Check paragraph Installing a smart charging network for more information.
- Is the smart energy meter still working correctly? Refer to the documentation of the device to troubleshoot.
- Is the RJ11/RJ12 correctly pinched? Please, make sure the wires are connected 'straight' (not twisted) and the RJ11/RJ12 connector is correct and firmly pinched.
- Is the smart meter using (D)SMR protocol version 4.0 or up? Lower protocol versions do not support Smart Charging. Please, discuss the possibilities to upgrade the smart meter with your distribution system operator.
- Using a P1 splitter? Please, check whether the connection works without using the P1 splitter. If it works without the splitter, the P1 splitter is likely faulty.
- The incorrect installation of a P1 range extender/signal converter or splitter may cause a communication loss. Please, refer to the documentation of the device to troubleshoot.

If the communication loss occurs after it has functioned properly before with the setup, the physical connection in the cable or connector might have broken. If the communication loss occurs occasionally, the issue might be caused by a weak P1 signal. Please check the following:

- Is the RJ11/RJ12 connector still correctly placed in the smart meter? To be sure, unplug the connector and plug back in securely.
- The P1 signal is only transportable over a 20 meter cable length. A longer distance between smart energy meter and charging station might result in a communication loss.
- Using a P1 range extender/signal converter? Please, refer to the documentation of the device to troubleshoot.

10.11 Charging station or SCN loses communication with Modbus TCP/IP meter or EMS

If the connection to a smart energy meter or EMS over Modbus TCP/IP is lost, a charging station or SCN will fall back to the set TotalSafeCurrent for Active Load Balancing. The ACE Service Installer shows the communication status over Modbus TCP/IP under the Live monitoring tab under States as well as the obtained values of the smart energy meter under Currents. If these are all 0 A, there is a communication loss. If this occurs during installation, please check the following:

- Is the cable between smart energy meter and charging station in a good condition? You may use an Ethernet cable tester to check the condition of your cable. Or test

the LAN by pinging the charging stations via the CMD console on the computer. Check paragraph Installing a smart charging network for more information.

- Is the smart energy meter still working correctly? Refer to the documentation of the device to troubleshoot.
- Is the smart energy meter in the same IP range and subnet as the charging station? Please note that you may need to reboot the charging station after changing the IP address of the charging station. Please make sure your laptop is in the same range as well, otherwise you won't be able to see the charger in the ACE Service Installer. You might need to disable and enable the network adapter in your laptop as well to make changed settings effective.
- Can the charging station obtain the data from the smart energy meter? The network must not block the data communication (over port 502).
- Within an SCN, only one charging station can be connected to the smart energy meter over Modbus TCP/IP. Please, make sure only one of the charging stations is configured to connect to the smart energy meter.

If the communication loss occurs after it has functioned properly before with the setup, the physical connection in the cable or connector might have broken or the network's configuration might have changed. Please, follow the steps in paragraph Configuration of a Smart Charging Network to make sure the network is set up properly.

Contact

Alfen ICU B.V.

Hefbrugweg 28
1332 AP Almere
The Netherlands

P.O. box 1042
1300 BA Almere
The Netherlands

Sales Support:

www.support.alfen.com

Tel. Service:

+31 (0)36 54 93 401

Website:

www.alfen.com/en/ev-charge-points

